

ARB BASE RACK

MAKE IT YOUR OWN



BUILD | ATTACH | SET | EXPLORE

Introducing the next phase in roof rack evolution, the ARB BASE Rack.

Ultra sleek, boasting a super low mounting profile and lightweight design, the BASE Rack provides unmatched simplicity, flexibility and personalisation in your roof rack set-up.

Setting a new benchmark in strength and integration, the BASE Rack incorporates a revolutionary dovetail mounting system that makes attaching and removing loads and accessories easier, faster and more secure.

With six sizes to suit a huge range of vehicle applications and an ever-growing array of complementary accessories, the BASE Rack represents your all-in-one solution and the last rack you'll ever need.



FEATURES

- Ultra sleek, low-profile design
- Fully welded construction for superior strength and rigidity
- Textured black powder-coat finish
- Lightweight, cast aluminium cross beam formation
- Unique new dovetail mounting extrusion offers greater versatility, flexibility and speed in accessory placement and attachment
- Dovetail design means less dirt entrapment (easy cleaning)
- Side-mounted fixing points allow for greater use of rack beams for cargo loading
- Purpose-designed range of quick-release dovetail accessories requiring few or no tools
- Removable end caps allow access to channel for installing hidden electrical cables for roof lighting and solar
- Compatible with existing T-slot accessories*

*Additional adaptors sold separately

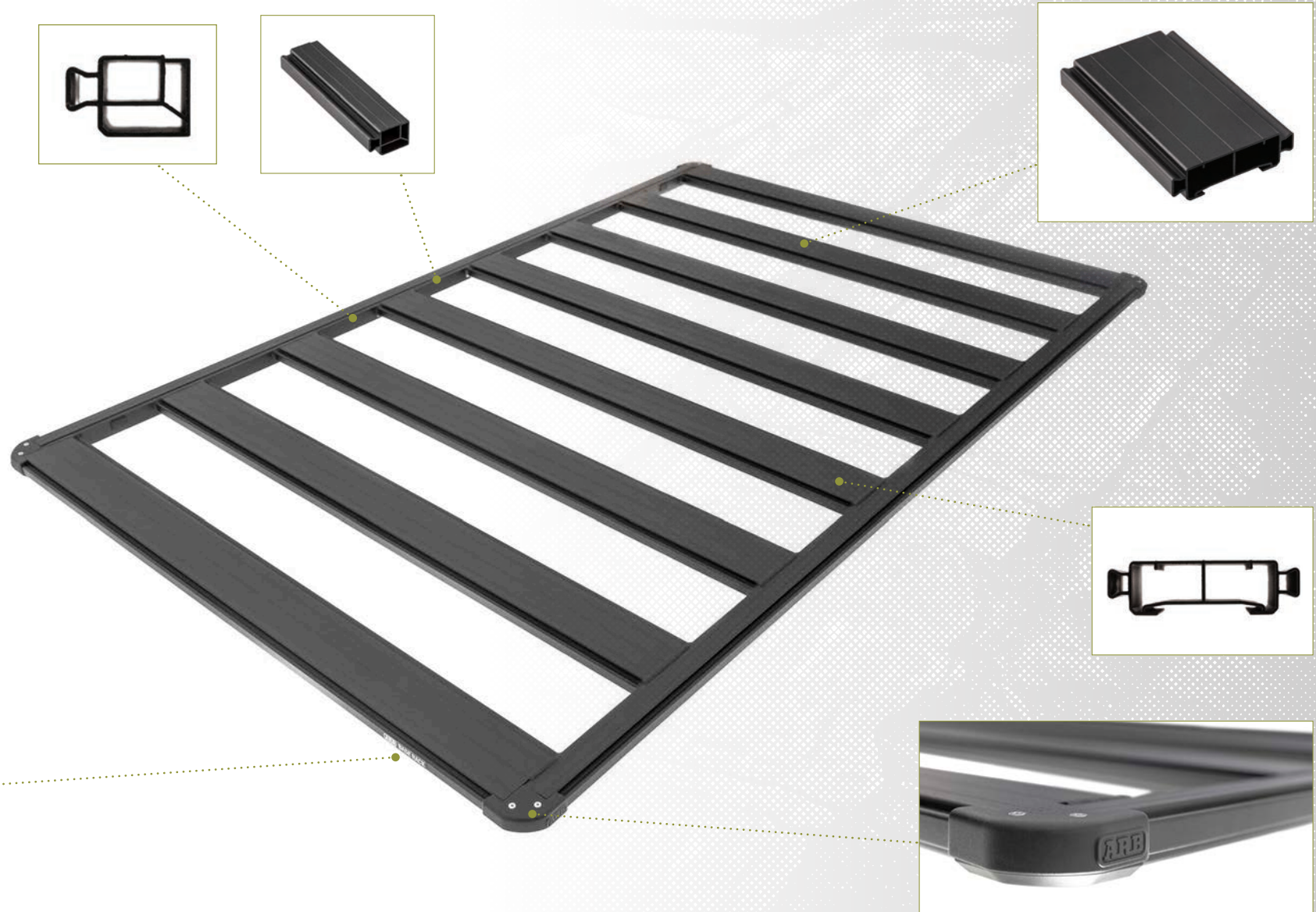

STRENGTH MEETS STYLE

Made from extruded aluminium, the BASE Rack's clever design mounts close to the roof line, doesn't require a supporting sub frame and exerts no flex under load.

Each beam is constructed from a single seamless box piece of aluminium with internal bracing for added strength and no screws or rivets. The BASE Rack is fully welded, providing a strength and load rating similar to a traditional steel rack at a fraction of the weight.

Unique in design, the BASE Rack runs its beams across the width of the vehicle, resulting in maximum strength and rigidity. This makes it easier to pack and carry almost anything.

Fitted to a range of low-profile blade mounts, the BASE Rack provides improved access into low clearance areas, all the while looking sleek on the roof of your pride and joy.

THE RANGE

The BASE Rack is available in a number of sizes to complement the vast range of 4WDs on the market.

Sizes/Dimensions:

1,255mm x 1,155mm - 12.7kg approximately

Best suited to dual-cab vehicle
Part no. 1770060

1,255mm x 1,285mm - 14.3kg approximately

Best suited to dual-cab vehicle
Part no. 1770070

1,545mm x 1,285mm - 16.6kg approximately

Best suited to single-cab vehicle, short canopy or wagon with sunroof
Part no. 1770020

1,835mm x 1,155mm - 17.7kg approximately

Best suited to narrow canopy
Part no. 1770010

1,835mm x 1,285mm - 19.9kg approximately

Best suited to wider canopy or smaller wagon
Part no. 1770030

2,125mm x 1,285mm - 22.8kg approximately

Best suited to larger cab wagon
Part no. 1770040

1,545 x 1,445 - 18.5kg approximately

Best suited to vans and larger cab wagon
Part no 1770080

1,835 x 1,445 - 21.5kg approximately

Best suited to vans and larger cab wagon
Part no 1770090

2,125 x 1,445 - 24.5kg approximately

Best suited to vans and larger cab wagon
Part no 1770100



MAKE IT YOUR OWN

The BASE Rack takes accessories and cargo loading to a whole new level of simplicity, speed and personalisation. With a choice of sizes, accessories and attachments, you can truly Make It Your Own.

By incorporating a dovetail extrusion around both the full perimeter and along each edge of the internal beams, the BASE Rack provides endless mounting and attachment options.

Adding, removing and repositioning accessories and roof loads is quick and easy with the BASE Rack's dovetail system, making it easier to install and remove individual items without disturbing the whole load. Plus, unlike traditional roof rack channels, the BASE Rack dovetail extrusion won't collect dust and debris.

Each BASE Rack accessory or fixture attaches to the rack with a simple clamp mount, including larger hardware such as Hi-Lift™ Jack mounts, rollers, recovery boards and even a BASE Rack custom light bar.





GUARD RAIL SYSTEMS

The BASE Rack is sold standard as a low-profile platform rack and can easily be transformed into a touring or trade rack by simply installing the rail system that best suits your needs.

The optional rails attach quickly and easily to the dovetail extrusion around the rack's perimeter. You can have a full guard rail system on or off in just a few minutes.

Full Rails

Designed for the tourer. The rails running around the perimeter of the rack act as a load block, helping to prevent larger items such as swags and tents from shifting when loading and unloading as well as during transit.



3/4 Rails

A cross between full and trade rails, 3/4 rails, along with an optional roller kit, assist with easy rear loading of large and awkward items whilst still providing load security at the front of the rack. Also designed for rear-folding rooftop tents, subject to tent width.



1/4 Rails

Perfect for campers, this style of rail is great for rooftop tents whilst still providing ample storage and load security at the front of the rack.



Trade Rails

The tradie option. Great for loading long items such as timber and ladders with an optional roller kit to help glide long or awkward items onto the rack. The side rails prevent items from slipping or rolling off the rack during loading and allow you to fill the rack right up to the edge.



ACCESSORIES



AWNING BRACKET



Mount your ARB awning securely. Available in classic and quick-release versions, the awning bracket allows quick fitment of your awning, meaning you spend less time at home packing and prepping and more time at your destination enjoying the great outdoors.

- Allows fitment of ARB's awning range
- Easy to attach to the BASE Rack – simply secure onto the dovetail track on the rack
- Can attach to the dovetail track at any point on the rack
- Made from strong powder-coated steel



To use:

Simply secure the awning bracket with provided fasteners to the dovetail track on the BASE Rack. Secure the ARB awning to the bracket and it is ready to use.

Part no. 1780240

QUICK-RELEASE AWNING BRACKET



- Allows fitment of ARB's awning range
- Can attach to the dovetail track on the perimeter of the rack
- Quick-release bracket allows your awning to be removed in no time
- Made from strong powder-coated steel



To use:

Simply attach fixed mount brackets to the dovetail on the perimeter of the BASE Rack. Attach quick-release mount bracket to the ARB awning and secure to the fixed mount bracket on the rack with provided fasteners. To release, loosen fasteners, then slide and lift.

Part no. 1780260

HEAVY-DUTY AWNING BRACKET

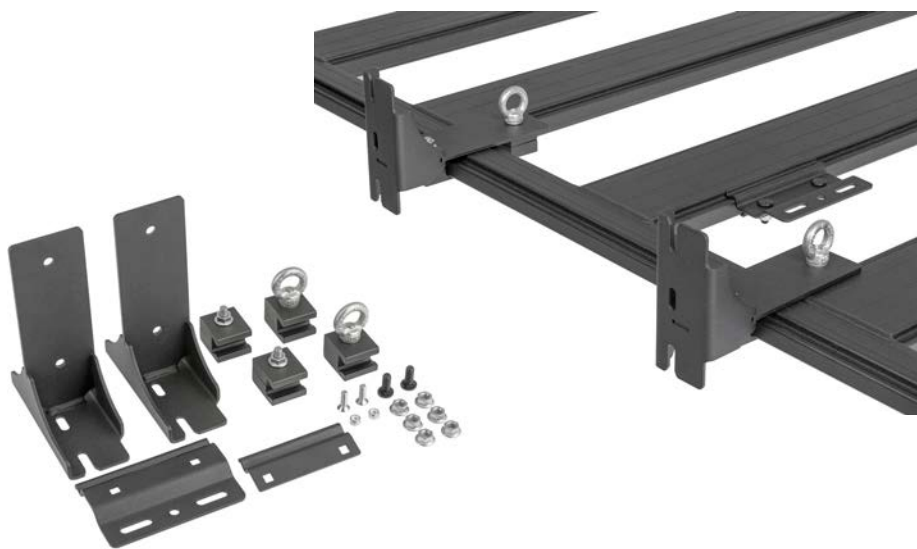

Got an awning and need brackets to support it? The heavy-duty awning mount means you can securely attach an awning weighing up to 25 kilograms to the BASE Rack.

- Designed to suit 270-degree awnings
- Integrated eye nut tie-down points
- Quick-release slots for easy install and removal
- High and low mount position
- Attaches to the sides and cross beams of the ARB BASE Rack
- Brackets are made from strong powder-coated steel

Part no. 1780390

NARROW BRIDGE PLATE

- Provides a strong, versatile attachment point
- Ideal for mounting rooftop tents
- Can be used as a clamped pair or mounted individually
- Four brackets per kit, includes fasteners

Part no. 1780420

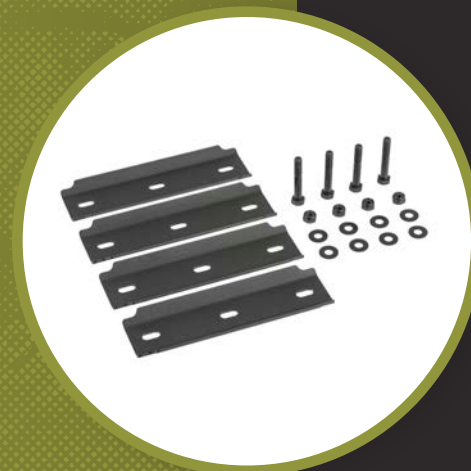
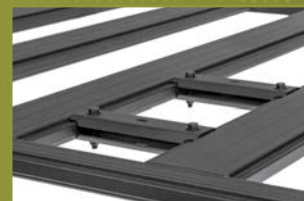

WIDE BRIDGE PLATE

- Suitable for mounting aerials, sand flags, some beacons, RotopaX™ and round driving lights
- Two brackets per kit, includes fasteners for clamp mounting
- Can be used as a clamped pair or individually mounted on alloy blocks
- Made from strong powder-coated steel

Part no. 1780430

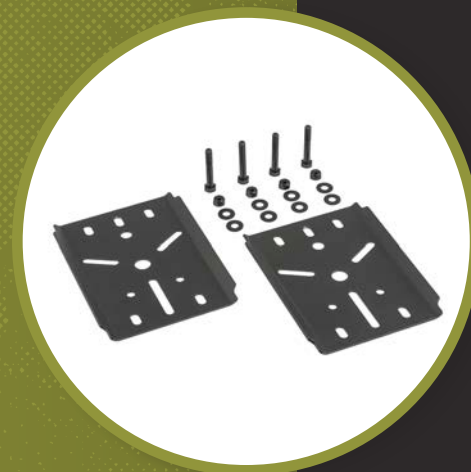



HORIZONTAL WIDE MOUNT

- Suitable for items up to six kilograms (13 pounds) per bracket
- Brackets made from strong powder-coated steel
- Provides a strong, versatile horizontal attachment point to BASE Rack
- Two brackets per kit, includes fasteners for mounting to rack



Part no. 1780450

HORIZONTAL NARROW MOUNT



- Can attach to the dovetail track on any location on the rack
- Suitable for mounting small items up to three kilograms (6.6 pounds) per bracket
- Brackets are made from strong powder-coated steel
- Two brackets per kit, includes fasteners for mounting to rack

Part no. 1780440

VERTICAL NARROW MOUNT AND VERTICAL WIDE MOUNT



- Provides a strong, versatile vertical attachment point to your BASE Rack
- The narrow mount is suitable for mounting small items up to three kilograms (6.6 pounds) per bracket
- The wide mount is suitable for mounting up to six kilograms (13 pounds) per bracket
- Two brackets per kit, includes fasteners for mounting to rack

Narrow mount part no. 1780460
Wide mount part no. 1780470



ROLLER KIT



Loading long pieces of timber and other heavy items can be tricky when you're alone but adding a roller to the end of your BASE Rack will alleviate this. The roller helps your equipment to glide onto the rack ready for you to secure and get on your way.

- Allows easy loading onto your BASE Rack
- Can attach to the dovetail track anywhere on the perimeter
- Made from powder-coated aluminium
- Makes long, heavy items easy to load safely onto the roof rack
- Full-width, low-profile roller

Available in two sizes:

1,025mm
Part no. 1780360

1,185mm
Part no. 1780365



To use:

Simply bolt the brackets to the dovetail track and attach roller.





ROOF RACK LIGHT BAR

- Unique reflector design to provide optimum distance and width for highway driving
- Reflector design limits light being reflected off vehicle bonnet and bar work
- Combo beam technology provides excellent mid- to long-range spread as well as distance down the road
- Virtually indestructible polycarbonate lens
- Protected against radio frequency (RFI) and electromagnetic (EMC) interference
- Two-pin, over-moulded, waterproof plug
- Suitable for use with ARB driving light loom – 3500810 and 3500820
- R10, CE and RoHS certified
- Three-year warranty



Light Bar Lens Cover also available:

- Contains two covers x 22.8 centimetres (9.0 inches)
- Virtually indestructible polycarbonate cover
- Available in clear, solid black and amber

Input	12V to 48V
Power	130W
Current Draw	9.2A @ 14.4V
Output - Raw	9,279 lumens
Output - Effective	8,552 lumens
Lux @ M (Single Light)	1 lux @ 728m
Spread	Horizontal 8° & Vertical 6°
Input Cable Length	330mm (male terminal)
Operating Temp	-40°C to +65°C (-40°F to +149°F)
Colour Temp	5,500-6,000K
Runtime	50,000hrs
Weight	3.07kg
Connector	2-pin, over-moulded, waterproof plug
Dimensions	954mm (37.55") (W) x 67mm (2.63") (L) x 34mm (1.33") (H)
Certifications	R10, CE & RoHS

Kit includes:

- 1 x 36-inch light bar
- 2 x Bracket for below rack mounting
- 2 x Bracket for front rack mounting
- 1 x Bracket mounting hardware

Part no. 1780500



AUXILIARY LIGHT

Light up the night with this compact and capable auxiliary light that attaches easily to any ARB BASE Rack. The 2.8-inch light is great for lighting up your campsite or workspace.



Part no. 1780520

Input	9V to 36V
Power	20W
Current Draw	1.67A @ 12V
LED	2 x 10W OSRAM®
Output	1,100 lumens
Colour Temp White	5,000K
Connector	Waterproof DT connectors
Spread	Flood 120°
Operating Temp	-40°C to +100°C (-40°F to +212°F) with thermal management
Runtime	50,000hrs
Weather Rating	IP69K

LIGHT BAR DOVETAIL MOUNT

- Mount to the dovetail track at any location
- Made from strong powder-coated steel
- Suitable for mounting small items up to 3.5 kilograms (7.7 pounds) per pair
- Includes fasteners for mounting to rack

Part no. 1780480



LIGHT BAR UNDER MOUNT

- Attaches to bottom of BASE Rack
- Suitable for mounting small items up to 3.5 kilograms (7.7 pounds) per pair
- Suitable for single-bolt, end-mount light bar and work lights
- Includes fasteners for mounting to rack

Part no. 1780490



RECOVERY TRACK HOLDER

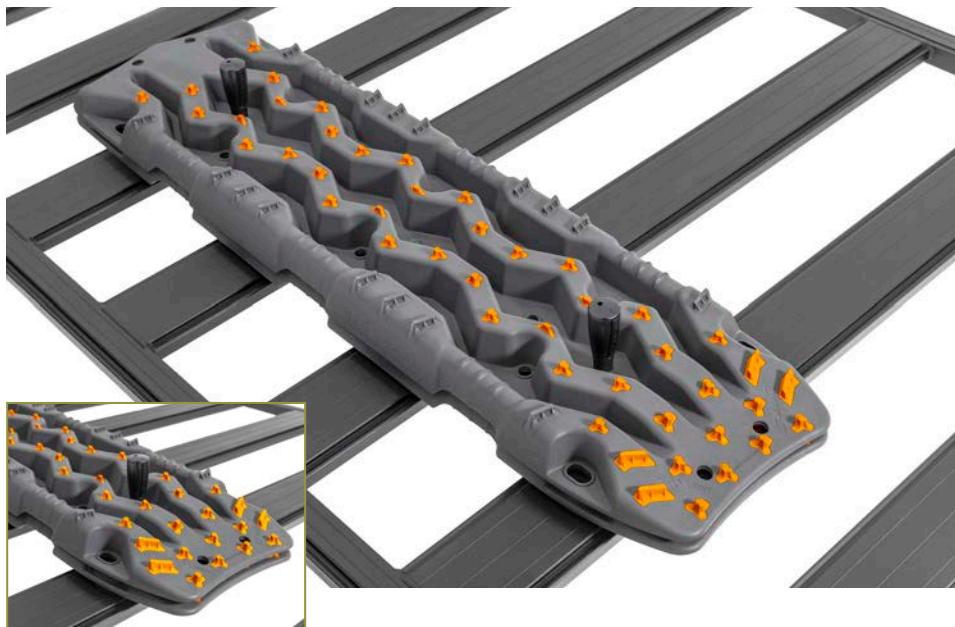

When you're stuck in the sand, you want to be able to access your recovery tracks quickly so you can get on with your adventure.

- Allows easy fitment of recovery tracks onto the BASE Rack
- Can attach to the dovetail track at any point on the rack
- Made from strong, corrosion-resistant steel
- To be used with track manufacturer's mounting hardware
- Suitable for use with MaxTrax and ARB TRED Pros (product-specific mounting hardware sold separately)

To use:

Simply bolt the four brackets with manufacturer's hardware to the dovetail track on the BASE Rack and follow manufacturer's direction to secure tracks.

Part no. 1780310



HI-LIFT JACK HOLDER



An off road jack is a 4WDer's best friend. When you're out on the tracks, you want easy access to your jack and the Hi-Lift™ Jack holder ensures your jack is always at hand. Available in both classic for simple jack attachment and premium for quick release and added security.

- Allows easy fitment of Hi-Lift™ Jack onto the BASE Rack
- Can attach to the dovetail track anywhere on the perimeter
- Made from strong, corrosion-resistant steel
- Includes rubber handle keeper

To use:

Simply bolt the mount bracket to the dovetail track. Secure the jack with the supplied forged steel eye nuts. To release the jack, remove the forged steel eye nuts.

Part no. 1780290



HI-LIFT JACK HOLDER (PREMIUM)



- Allows easy fitment of a Hi-Lift™ Jack to your BASE Rack
- Can attach to the dovetail track anywhere on the perimeter
- Made from strong powder-coated steel
- Padlock provision for added security
- Quick-release loading and unloading of jack

To use:

Simply bolt the two brackets to the dovetail track. Place the jack in the brace and clip closed.

Part no. 1780280



GAS BOTTLE HOLDER



Keeping a gas bottle safe and secure is a must when travelling. Attaching and removing your gas bottle is a breeze with the gas bottle holder. It can be secured to an individual beam or span between beams.

- Allows easy fitment of a gas bottle to your BASE Rack
- Suits gas bottles between two kilograms and nine kilograms
- Secures to an individual beam or spans between beams
- Eye bolts and strap included to secure gas bottle
- Durable baseplate with adjustable stainless steel locking bracket
- Solid aluminium clamps and forged steel eye nuts
- Can attach to the dovetail track at any point on the rack
- Made from strong powder-coated steel



To use:

Simply attach the gas bottle holder to the dovetail track using the two forged steel eye nuts. Secure the gas bottle using the ratchet strap supplied by attaching to each eye nut.

Part no. 1780250

JERRY CAN HOLDER DOUBLE HORIZONTAL

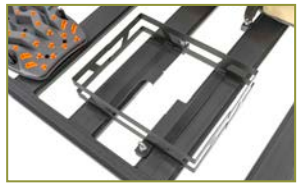

It is often essential to carry extra fuel or water on an off road trip. Rest assured you can always be prepared with four jerry can holder sizes, perfect to suit your individual needs.

- Allows easy fitment of two jerry cans to your BASE Rack
- Mounts horizontally
- Secures to two beams
- Solid aluminium clamps with forged steel eye nuts, strap included
- Can attach to the dovetail track at any point on the rack
- Holder made from strong powder-coated steel



To use:

Simply attach the jerry can holder to the dovetail track using the two forged steel eye nuts. Secure the jerry can using the ratchet strap supplied by attaching to each eye nut.

Part no. 1780350

JERRY CAN HOLDER DOUBLE VERTICAL



- Allows easy fitment of two jerry cans to your BASE Rack
- Mounts vertically
- Provision for water tap
- Secures to two beams
- Solid aluminium clamps with forged steel eye nuts, strap included
- Can attach to the dovetail track at any point on the rack
- Holder made from strong powder-coated steel



To use:

Simply attach the jerry can holder to the dovetail track using the two forged steel eye nuts. Secure the jerry can using the ratchet strap supplied by attaching to each eye nut.

Part no. 1780340

JERRY CAN HOLDER SINGLE HORIZONTAL



- Allows easy fitment of a jerry can to your BASE Rack
- Mounted horizontally
- Secures to individual beam or spans between beams
- Solid aluminium clamps with forged steel eye nuts, strap included
- Powder-coated steel support plate
- Can attach to the dovetail track at any point on the rack
- Holder made from strong powder-coated steel



To use:

Simply attach the jerry can holder to the dovetail track using the two forged steel eye nuts. Secure the jerry can using the ratchet strap supplied by attaching to each eye nut.

Part no. 1780330

JERRY CAN HOLDER SINGLE VERTICAL



- Allows easy fitment of a jerry can to your BASE Rack
- Mounted vertically
- Provision for water tap
- Secures to an individual beam or spans between beams

- Solid aluminium clamps with forged steel eye nuts, strap included
- Powder-coated steel support plate
- Can attach to the dovetail track at any point on the rack
- Holder made from strong powder-coated steel
- Accommodates 10-litre and 20-litre jerry cans



To use:

Simply attach the jerry can holder to the dovetail track using the two forged steel eye nuts. Secure the jerry can using the ratchet strap supplied by attaching to each eye nut.

Part no. 1780320

SPARE WHEEL Y-STRAP



Secure your spare wheel on your BASE Rack with ease, ready to tackle your next adventure. These spare wheel straps are easy to use and will secure your load in no time at all.

- 25-millimetre polyester webbing
- For use with BASE Rack without the need for additional tie-down points
- 150-kilogram lashing capacity to AS/NZS 4380:2001
- Adjustable one-metre straps suit most tyre sizes
- Supplied with carry bag

To use:

Simply weave two adjuster straps through the Y-plate and feed the third strap through the ratchet. Hook onto the BASE Rack dovetail, adjust to centre and tighten.

Part no. 1780380



RATCHET STRAP (PAIR)



Ensure all your gear is safe and secure on your BASE Rack. These ratchet straps are easy to attach to the rack and will give you peace of mind when carrying bulky items.

- Three-metre by 25-millimetre polyester webbing
- For use with BASE Rack without the need for additional tie-down points
- 200-kilogram lashing capacity to AS/NZS 4380:2001
- Set of two per pack
- Supplied with carry bag

To use:

Simply hook strap ends onto the BASE Rack dovetail, feed through ratchet and tighten.

Part no. 1780370



EYE BOLT TIE-DOWN (SET OF FOUR)



Secure your gear quickly and safely. From items such as timber and ladders to swags and camping gear, these eye bolt tie-downs are built tough to handle any load and terrain.

- Provides a lashing point for ratchet straps
- Designed to stay securely on the BASE Rack when not in use
- Can attach to the dovetail track at any point on the rack
- Made from strong powder-coated aluminium
- Forged steel eye nuts
- Set of four per pack

To use:

Simply attach the tie-down point to the dovetail track on the BASE Rack and tighten. Secure the ratchet straps to each tie-down and pull tight to secure load.

Part no. 1780200

ALLOY BLOCK SET



- Strong attachment point
- Compatible with other BASE Rack accessories
- Set of four per pack
- Made from strong powder-coated aluminium

Part no. 1780610

SPRING-LOADED TIE-DOWN (PAIR)



Quick-attach spring-loaded tie-downs are easy to use with a simple one-handed operation. Great for one-off needs and quick loading and unloading.

- Quick attachment and release
- Provides a lashing point for ratchet straps
- Easy to attach to the roof rack
- Designed to be taken off the rack when not in use by a simple half turn
- Can attach to the dovetail track at any point on the rack
- Made from strong stainless steel
- Set of two per pack



To use:

Simply place over dovetail track flat side down. Rotate 180°. Hook lashing through ring and tighten. Remove from BASE Rack when not in use.

Part no. 1780210

WIND DEFLECTOR



No longer will there be the fear of additional cabin noise when fitting a roof rack. ARB's engineers have designed an underside-mounting wind deflector, ensuring a quiet and enjoyable driving experience.

- 1.6-millimetre press-formed aluminium
- Press-form shape provides rigidity and strength and aids noise reduction (in technical terms, it reduces vortex shedding effects)
- Durable powder-coat finish
- Vehicle specific
- Pre-cut slots to aid fitment of front-mounted roof rack light bar
- Significantly reduces wind noise associated with roof racks (almost eliminates it on most vehicles)



T-SLOT ADAPTOR (SINGLE OR PAIR)



For the active outdoor adventurer. For use with your existing T-slot compatible accessories. From your bike carrier to your kayak holder, the T-slot adaptor bracket ensures you can easily attach anything to the BASE Rack.

- Allows fitment of accessories from a range of roof rack manufacturers
- Uses a standard T-slot channel to accept T-slot mounted accessories
- Can attach to the dovetail track at any point on the rack
- Made from strong powder-coated aluminium
- Available as single or pair



To use:

Simply attach the T-slot adaptor to the dovetail track on the BASE Rack. Attach the accessory to the T-slot adaptor as per manufacturer's instructions.

Single part no. 1780220

Pair part no. 1780230



4X4 ACCESSORIES