



BUSHRANGER
4x4 GEAR
CATALOGUE
2021



RRP subject to change. Listed recommended retail prices are for the Australian Domestic Market.



RECOVERY

SNATCH STRAP

Part No: RS Series
RRP: From \$69



Part no.	Min. Breaking strain	Weight	RRP
RSS08	8,000kg	2.3kg	\$69
RSS11	11,000kg	3kg	\$99

Features

- Added protective eyelets to ensure maximum strength when used with shackles and hooks.
- Strap usage recording tags located with the compliance tags, the usage tags allow you to record and track the number of times the strap is used to help identify fatigue and age of the strap.
- Easy storage wrap it strap, stitched to the snatch strap so it is ready to roll up and use any time.
- Designed and tested to comply with the latest Australian Consumer Goods [Motor Vehicle Recovery Strap] Safety Standard 2017.
- Manufactured from high-quality nylon material & reinforced stitching.

Specifications

- Stretch: Genuine 20%
- Material: All nylon stretch webbing
- Length: 9m
- Width: 75mm
- Warranty: 5 years

TREE TRUNK PROTECTOR

Part No: RST11
RRP: \$45



Features

- Added protective eyelets to ensure maximum strength when used with shackles and hooks.
- Located with the compliance tags, the usage tags allow you to record and track the number of times the strap is used to help identify fatigue and age of the strap.
- Easy storage wrap it strap, stitched to the tree trunk protector, so it is ready to roll up and use any time.
- Manufactured from a high-quality polyester material & reinforced stitching.

Specifications

- Capacity: 11,000kg
- Length: 3 metres
- Width: 100mm
- Material: 100% Polyester
- Weight: 1.41kg
- Warranty: 5 year

WINCH EXTENSION STRAP

Part No: RSW05
RRP: \$49



Features

- Added protective eyelets to ensure maximum strength when used with shackles and hooks.
- Located with the compliance tags, the usage tags allow you to record and track the number of times the strap is used to help identify fatigue and age of the strap.
- Easy storage wrap it strap, stitched to the tree trunk protector, so it is ready to roll up and use any time.
- Manufactured from a high-quality polyester material & reinforced stitching.

Specifications

- Capacity: 5,500kg
- Length: 10 metres
- Width: 50mm
- Material: 100% Polyester
- Weight: 1.75kg
- Warranty: 5 year

SNATCH KIT

Part No: Various
RRP: Various

The Bushranger® Snatch Kit is a 4x4 essential for any driver. The Bushranger kit is a compact durable bag with a m x snatch strap, 2 x bow shackles and a pair of gloves. Take advantage of the extra pockets to store your other recovery gear.

Specifications

- Standard kit contains:
9m x 8,000kg snatch strap, 2 x 3.25t bow shackles and a pair of gloves
- Heavy duty kit contains:
9m x 11,000kg snatch strap, 2 x 4.75t bow shackles and a pair of gloves
- Warranty: 5 year; excluding storage bag & gloves: 1 year warranty.

Part no.	Description	RRP
RKS08	Snatch kit, standard	\$119.00
RKS11	Snatch kit, heavy duty	\$140.00



WINCH RECOVERY KIT

Part No: RKW10K
RRP: \$299.00

The Bushranger® Recovery Kit gives you peace of mind. Best suited to a 10,000lb winch, carrying a complete recovery solution, if you become stuck you'll have the tools to get yourself out and home safe.

The compact bag is complete with a 9m x 8,000kg snatch strap, 11,000kg trunk protector, 10m x 5,500kg winch extension strap, 2 x 3.25t & 2 x 4.75t bow shackles, 11,000kg snatch block, recovery damper and a pair of gloves.

Specifications

- Kit contains: Bag, 9m x 8,000kg snatch strap, 11,000kg trunk protector, 10m x 5,500kg winch extension strap, 2 x 3.25t & 2 x 4.75t bow shackles, 11,000kg snatch block, recovery damper and a pair of gloves.
- Warranty: Various. See products in catalogue.



RECOVERY

TYRE MAINTENANCE

LIGHTS

COMPRESSORS

CAMPING

VEHICLE PROTECTION

SIDE STEPS

WINDOWS

SNATCH BLOCK

Part No: RBS11
RRP: \$79



Features

- Tapered pulley design that allows for multiple sized ropes to be used in the one product.
- Rounded edges assist with guiding the rope in and out of the snatch block but also prevents damage to both synthetic and wire ropes.
- Upswept tabs on the side plates offer additional rigidity but also allow for smooth operation.

Specifications

- Working load: 11,000kg
- Minimum breaking strength: 18,000kg
- Dimensions: 197mm x 105mm x 50mm
- Material: UV stable matt black powder coated 6mm steel side plates
- Bearing: Precision machined steel with grease nipple axle
- Rope type: Suitable for synthetic or wire rope up to 12mm diameter
- Weight: 2.5kg
- Warranty: 5 Years

BOW SHACKLES

Part No: Various
RRP: \$66



Part no.	Capacity	Dimensions	Weight	Box	RRP
58X01	3.25t	106mm x 75mm	580g	8	\$66.00
58X02	4.75t	109mm x 89mm	760g	6	\$77.00

Specifications

- Material: Corrosion resistant AU standard material grade S/6
- Warranty: 5 years

RECOVERY GLOVES

Part No: 73X17-A
RRP: \$35



Features

- Kevlar reinforced palm patches for premium palm protection.
- Reinforced wear points will ensure more excellent protection and longevity of the gloves.
- The cuff includes a touch tape fastener to keep the glove firmly fitted.

Specifications

- Material: Kevlar reinforced palms
- Weight: 100g
- Warranty: 1 year

RECOVERY BAG

Part No: 60X01-A
RRP: \$39

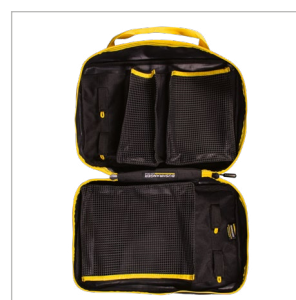

Features

- Made from heavy-duty polyester material with mesh pockets and webbing straps.
- Water and dust resistant.
- Traditional design, to fit in most draw systems and minimise wasted space.
- Extra storage pockets.

Specifications

- Dimensions: 300mm x 450mm
- Material: Polyester
- Weight: 880g
- Warranty: 1 year

DRAG CHAIN

Part No: 58X10
RRP: \$84.70



The Bushranger® Drag Chain is designed to pull or move obstructions. Five metres steel chain with master link and grab hook comes in a handy storage bag.

Specifications

- Capacity: 3,800kg (straight line) 2,850kg (looped)
- Dimensions: 5 metres
- Material: Steel G70
- Weight: 8kg
- Warranty: 5 year

RECOVERY DAMPER

Part No: 61X05-A
RRP: \$40



The Bushranger® Recovery Damper helps to reduce the risk of injury in the event of a strap or cable breakage.

In the event of a failure the recovery damper will absorb most of the energy in the cable or strap, thereby significantly reducing the recoil and force the line to drop straight down to the ground.

Features

- Heavy duty reinforced PVC with reflective tape.
- Internal weight pockets and extra pocket if extra weight is required.
- Wide Velcro tabs.
- Suitable for competitions.

Specifications

- Dimensions: 50.5cm x 50cm x 1cm
- Material: Heavy duty reinforced PVC
- Weight: 1.1kg minimum
- Warranty: 1 year

RECOVERY HITCH & SHACKLE COMBO

Part No: 58X22 series
RRP: From \$59.95



Part no.	Dimensions	Weight	RRP
58X22/A	170mm x 110mm x 50mm	3.3kg	\$59.95
58X22/B	215mm x 110mm x 50mm	4.1kg	\$65.00

Features

- Slides into a 50mm towbar receiver and locks into place using the pull pin and clip.
- Recovery hitch has twin slotted holes so it can be mounted horizontal or vertically to suit the recovery situation.

Specifications

- Capacity: Load rated 5,000kg | Bow shackle 4.75t
- Material: Zinc coated
- Warranty: 5 years

TOW HOOK WITH KEEPER

Part No: 59X00
RRP: \$22



The Bushranger® Tow Hook adds an extra tow point to your vehicle chassis to aid recovery. Featuring a heavy duty black powder coated finish, and spring keep to avoid straps and shackles falling out.

Specifications

- Capacity: 4.5 tonne (safe working load)
- Material: Drop forged, high strength steel
- Weight: 1kg
- Warranty: 5 years

X-TRAX II RECOVERY TRACKS

Part No: 54X07
RRP: \$225.50

Compact recovery track, easy to deploy for vehicle recoveries. Quick, no fuss clean-up with X-Trax folding back up into supplied durable vinyl wrap.

Features

- Material: Made from heavy duty rubber, and galvanised steel cables and fittings.
- Multi-terrain: Suitable in sand, mud, or snow.
- Quick release, durable vinyl carry wrap with velcro closure.
- Compact recovery track, easy to deploy for vehicle recoveries. Quick, no fuss clean-up with X-Trax folding back up into supplied durable vinyl wrap.

Specifications

- Dimensions: Open | 1400mm (L) x 300mm (W) x 50mm (D), Closed | 500mm (L) x 300mm (W) x 140mm (D)
- Weight: 16.4kg (pair)
- Warranty: 5 year

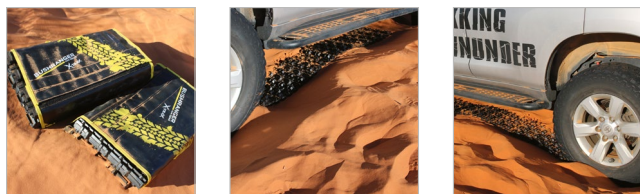

SAFETY FLAG

Part No: SF02A
RRP: \$126.50

Features

- Highly visible at 30 x 29cm in fluorescent orange flag with reflective cross tape.
- Can be mounted at multiple heights up to 3m making it extremely versatile.
- It's engineered tough with heavy duty quick connectors, a solid 3 piece fibreglass pole, stainless steel threaded joints, and chrome plated mounting hardware.
- Easy to install, remove and compactly packs away in provided bag when not in use.
- Designed to meet the South Australian safety flag requirements for use in the Flinders Ranges and Simpson Desert.

Specifications

- Dimensions: Flag size 300mm x 290mm .
- Material: Fluorescent orange flag with silver reflective cross.
- Dimensions: 1226mm x 100mm x 40mm (packed)
- Weight 1.35kg
- Warranty: 1 year

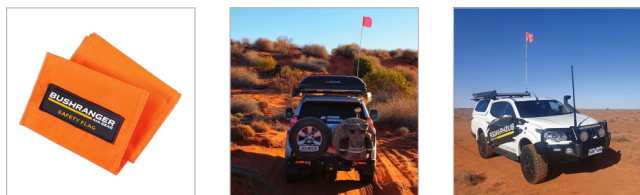

Part no.	Description	RRP
SF02A	Safety flag 3 piece	\$126.50
SF01A-01	Safety flag quick release	\$20.00
SF01A-03	Safety flag, orange with reflective X	\$20.00
SF01A-02	Safety flag, fibreglass pole, 12.7mm x 1m	\$37.00
SF01A-04	Safety flag storage bag	\$25.00

X-JACK | EXHAUST JACK

Part No: 72X10
RRP: \$350



Bushranger® X Jack is designed and engineered to perfection. This award-winning product has a long history in the Australian landscape and put to the test many times. The X-Jack has a triple layer top with a hardcore for maximum protection and stability. The patented two-way inflation system can utilise exhaust or a portable air compressor inflation which provides added control in rate and extent of lift required.

The X Jack assists lifting vehicle in a diverse range of situations or conditions such as sand, mud, snow or soft ground. Total lift height of 75cm. Total lift 2 tonnes.

Features

- Dual inflation | Dual alternatives for inflation provide the option of completing the inflation process by connecting a portable compressor to the X jack valve inlet or by the exhaust. (High temp hose included to 140°C.)
- Quality construction | The hard top integrated between two layers of reinforced PVC provides structure, reducing the risk of puncture during inflation and deflation.
- Convenient | Due to the X-Jacks inflatable nature, it goes anywhere, collapsing flat for easy storage into a heavy duty storage bag.

Specifications

- Capacity: GVM 4 tonne, max lift 2 tonne
- Pressure capacity: 10 psi
- Height: 75cm
- Weight: 8.6kg
- Material: Reinforced PVC
- Warranty: 1 year

Kit Includes: 1 x X-Jack, 2 x filler tubes, 1 x leather gloves, 1 x protective mat, puncture repair kit, heavy duty storage bag, coated operating instructions.

NOTE: X Jack will not inflate vehicles with an acute angle exhaust or dual exhaust. Vehicles with acute angle exhaust include Toyota Landcruiser 100 Series, Toyota Landcruiser 80 Series, and the Nissan Patrol GU. Please use the X Jack compressor feature to inflate or alternatively an ancillary extension pipe is available free of charge* by contacting customer service on 1800 654 767. This allows the rubber cone on the hose of the X Jack to fit snug.

*Australian only.

EXHAUST JACK II

Part No: 72X04
RRP: \$240

Simple & easy to use: no complicated moving parts, no jamming or seizing. Reliable and ready to go.
Quick recovery: will safely lift your vehicle up out of a bog in seconds.

Specifications

- Height: 78cm (30") lift
- Weight: 7kg (1.9kg Jack)
- Capacity: GVM 4 tonne (4,000kg), total lift 2 tonne (2,000kg)
- Material: 840 Denier Nylon with PVC coating to both sides
- Kit Includes: 1 x exhaust Jack, 3 x protective mats, 1 x gloves, puncture repair kit, storage bag, coated operating instructions
- Warranty: 1 year

Part no.	Description	RRP
72X04	Exhaust jack II	\$240.00
72X05K	Xtreme high temperature hose	\$66.00
72X05A	Exhaust jack puncture repair kit	\$7.00
73X21	Protective mat, 87cm x 87cm	\$8.00
72X05C	Exhaust jack hose, inc. fittings, 4" cone	\$66.00

HI-LIFT JACK

Part No: 75X00
RRP: \$198

The Hi-Lift Mechanical Jack designed and engineered tough. A must have for any off-road adventurer, a simple tool designed to lift a trapped vehicle from a boggy situation. An ideal choice for extraction when a winch or isn't an option or you've had an electrical failure. It happens, and it's nice to know you have options if it does.

Specifications

- Specifications: 122cm Tall with 94cm continuous lift, low pick up 12cm from base, lifting nose 10cm.
- Capacity: 1050kg AS/NZS 2693:2003 Vehicle jacks
- Weight: 14kg
- Suits: lifting, pushing, pulling, winching and hoisting
- Warranty: 1 year

Part no.	Description	RRP
75X00	Hi-lift jack	\$198
BL250	Hi-lift jack, bumper lift	\$74.00
FK1	Hi-lift jack, fix it kit	\$41.00
ORB	Hi-lift jack, off road base	\$114.00
LM100	Hi-lift jack, lift mate wheel adaptor	\$98.50



Part no.	Description	RRP
72X05D	Exhaust jack release valve seal kit	\$11.00
72X05E	Exhaust jack 4" cone	\$12.50
72X05F	Exhaust jack hose extension, 1450mm	\$49.50
72X05H	Exhaust jack PVC extension	POA
72X05J	Exhaust jack 5" large cone, suitable F250	\$27.50

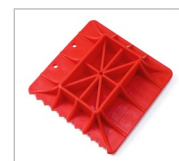

EXTRACTA HAND WINCH

Part No: 50X01
 RRP: \$495

Bushranger® Extracta Hand Winch is a durable, lightweight winch and lift. Designed to pull up to 2.5 tonne, and/or lift up to 1.6 tonne.

The overload shear pin, prevents damage to the winch by overloading the application ratings. Unit is supplied with two additional shear pins and the reverse lever still functions to loosen load once overloaded. Tested to AS1418:2 standard.

The kit includes: Extracta, 20m steel wire rope, cable reeler, carry bag and boot.

Specifications

- Dimensions: Housing: 54 L x 29 W x 10 D, Telescopic handle: 80cm, Cable Reeler: 120cm extended.
- Weight: 12kg
- Capacity: 2.5 tonne (pull) 1.6 tonne (lift)
- Material: Corrosion free aluminium body
- Warranty: 5 Year (Extracta) 1 year (boot and bag)

Part no.	Description	RRP
50X01	Extracta, hand winch, 2500kg	\$495.00
50X06	Extracta, cable pack with carry bag	\$27.50
50X05	Extracta, boot with carry bag	\$27.50



50X06



50X05

BUSHRANGER
4x4 GEAR

REVO

LIMITED

**LIFETIME
WARRANTY**

7 YEAR
ELECTRICAL
WARRANTY



Designed and engineered locally. Boasting market leading performance, high quality construction, unique design features, such as powering out under no load.

Available in 10,000lb & 12,000lb models in synthetic wireless, and wire rope options.

CLOCK-ABLE MOTOR HOUSING

3 Position motor clocking for versatility during fitting.



4 STAGE OVERSIZED GEARBOX

Designed for maximum strength and durability. Extra wide gears improve load distribution resulting in less wear and increased long term reliability. Externally adjustable, 16 position gearbox clocking for ease of fitment and use.

NO-LIFT CLUTCH

Easy to use spring-loaded cam style clutch mechanism.



GEARBOX MOUNTED BRAKING SYSTEM

100% load holding, proportional friction braking system located inside the gearbox, away from the drum - eliminating heat transfer to the synthetic rope.

ZERO DRAG BRAKE

Zero-Drag braking system allows for the winch to be powered out under no load without heat build up, making unspooling a breeze.

PREMIUM MOTOR DESIGN

Series wound, motor made with high-grade materials resulting in low current draw and longer life at extreme load.

10,000LB, 12V, 5.2HP
12,000LB, 12V, 6.2HP

TOUGH DESIGN

Strong and lightweight aluminum alloy housings with durable black powder coat finish.

WATERPROOF

Fully sealed motor, gearbox and drum for maximum protection from water, dust and debris.



WATERPROOF
IP130MIN
IP67 RATED

SYNTHETIC WINCH



IN-LINE/OFFSET HAWSE FAIRLEAD

Innovative two position, aircraft grade aluminum design to suit in-line and offset mounting requirements.



IN-LINE/OFFSET ROLLER FAIRLEAD

Unique, stainless steel rollers will not rust or peel. Tough, powder coated steel frame for maximum durability.



SYNTHETIC ROPE

Premium, synthetic rope paired with a removable clevis hook.

10,000lb, 10mm x 28m
12,000lb, 11mm x 25m



WIRE ROPE

Tough steel cable paired with a removable clevis hook.

10,000lb, 9.2mm x 28m
12,000lb, 10.3mm x 25m



WIRELESS HAND CONTROLLER

Fully sealed, IP67 rated, ergonomic hand controller with long range. Sealed 433MHz wireless receiver mounted internally to control box.



WIRED HAND CONTROLLER

Fully sealed, IP67 rated, ergonomic hand controller with 5m of cable for plenty of reach.

REVO WINCH | 10,000LB | SYNTHETIC ROPE

Part No: RWR100S
RRP: \$1,045



Specifications

- Dimensions: 583mm (L) x 165mm (W) x 216mm (H) (excludes control box)
- Rated Line Pull (single): 10,000lbs (4,536kg)
- Motor: Series wound, 12V, 5.2HP (3.9kw)
- Remote Control: Two functions, hand controller (Wireless, 30m range) (Wired, 5m lead)
- Electrical: Contactor IP67 500A
- Gear Train: 4 stage gear driven
- Gear Ratio: 171:1
- Clutch (freespooling): Rotating Ring Gear
- Brake: Gearbox Mounted, Proportional Friction Brake System
- Drum Diameter/Length: 63.5mm x 244mm
- Drum Diameter/Length: 63.5mm x 244mm
- Mounting: Bolt Pattern 254mm x 114mm
- Rope: 10mm x 28m Synthetic Rope
- Fairlead: Two position Aluminium Hawse Fairlead
- Recommend Battery: 650CCA minimum
- Battery Leads: 1850mm
- Finish: Black Powder Coat
- Mechanical Warranty: Limited Lifetime
- Electrical Warranty: 7 years
- Waterproof Rating: IP67
- Certification: CE, IP67
- Winch Weight: 33kg
- Packaged Weight: 37kg

Performance specifications

1st Layer of Drum

Load (kg/lb)	Line Speed(mpm/fpm)	Motor Current (amps)
No load	15/49	45
1816/4000	3.6/11.8	206
2724/6000	2.9/9.5	270
3632/8000	2.4/7.9	329
4540/10000	1/3.3	392

Pull by Layer - Synthetic Rope

Layer	kg/lb	Total Rope on Drum (m/ft)
1	4536/10000	5.1/16.7
2	3561/7849	11.4/37.4
3	2930/6460	18.6/61
4	2490/5489	26.7/87.6
5	2164/4771	28/92

REVO WINCH | 10,000LB | WIRE ROPE

Part No: RWR100W
RRP: \$945



Specifications

- Dimensions: 583mm (L) x 165mm (W) x 216mm (H) (excludes control box)
- Rated Line Pull (single): 10,000lbs (4,536kg)
- Motor: Series wound, 12V, 5.2HP (3.9kw)
- Remote Control: Hand controller (Wired, 5m lead)
- Electrical: Contactor IP67 500A
- Gear Train: 4 stage gear driven
- Gear Ratio: 171:1
- Clutch (freespooling): Rotating Ring Gear
- Brake: Gearbox Mounted, Proportional Friction Brake System
- Drum: Diameter/Length 63.5mm x 244mm
- Mounting Bolt Pattern: 254mm x 114mm
- Rope: 9.2mm x 28m Wire Rope
- Fairlead: Stainless Steel Roller Fairlead
- Recommend Battery: 650CCA minimum
- Battery Leads: 1850mm
- Finish: Black Powder Coat
- Mechanical Warranty: Limited Lifetime
- Electrical Warranty: 7 years
- Waterproof Rating: IP67
- Certification: CE, IP67
- Winch Weight: 44kg
- Packaged Weight: 49kg

Performance specifications

1st Layer of Drum

Load (kg/lb)	Line Speed(mpm/fpm)	Motor Current (amps)
No load	15/49	45
1816/4000	3.6/11.8	206
2724/6000	2.9/9.5	270
3632/8000	2.4/7.9	329
4540/10000	1/3.3	392

Pull by Layer - Wire Rope

Layer	kg/lb	Total Rope on Drum (m/ft)
1	4536/10000	5.5/18
2	3561/7849	12.2/40
3	2930/6460	19.8/65
4	2490/5489	28/92

REVO WINCH | 12,000LB | SYNTHETIC ROPE

Part No: RWR120S
RRP: \$1,195



Specifications

- Dimensions: 602mm (L) x 165mm (W) x 216mm (H) (excludes control box)
- Rated Line Pull (single): 12,000lbs (5,443kg)
- Motor: Series wound, 12V, 6.2HP (4.6kw)
- Remote Control: Two functions, hand controller (Wireless, 30m range) (Wired, 5m lead)
- Electrical: Contactor IP67 500A
- Gear Train: 4 stage gear driven
- Gear Ratio: 171:1
- Clutch (freespooling): Rotating Ring Gear
- Brake: Gearbox Mounted, Proportional Friction Brake System
- Drum Diameter/Length: 63.5mm x 244mm
- Mounting: Bolt Pattern 254mm x 114mm
- Rope: 11mm x 24m Synthetic Rope
- Fairlead: Two position Aluminium Hawse Fairlead
- Recommend Battery: 650CCA minimum
- Battery Leads: 1850mm
- Finish: Black Powder Coat
- Mechanical Warranty: Limited Lifetime
- Electrical Warranty: 7 years
- Waterproof Rating: IP67
- Certification: CE, IP67
- Winch Weight: 35kg
- Drum Diameter/Length: 63.5mm x 244mm

Performance specifications

1st Layer of Drum

Load (kg/lb)	Line Speed (mpm/fpm)	Motor Current (amps)
No load	16/52.4	47
1816/4000	3.2/10.5	180
2724/6000	2.4/7.9	230
3632/8000	1.9/6.2	280
4540/10000	1.5/4.9	320
5443/12000	1/3.3	420

Pull by Layer - Synthetic Rope

Layer	kg/lb	Total Rope on Drum (m/ft)
1	5443/12000	4.2/13.7
2	4195/9250	9.3/30.5
3	3413/7525	14.5/47.5
4	2877/6343	20/65.6
5	2486/5481	24/79

REVO WINCH | 12,000LB | WIRE ROPE

Part No: RWR120W
RRP: \$1,095



Specifications

- Dimensions: 602mm (L) x 165mm (W) x 216mm (H) (excludes control box)
- Rated Line Pull (single): 12,000lbs (5,443kg)
- Motor: Series wound, 12V, 6.2HP (4.6kw)
- Remote Control: Hand controller (Wired, 5m lead)
- Electrical: Contactor IP67 500A
- Gear Train: 4 stage gear driven
- Gear Ratio: 171:1
- Clutch (freespooling): Rotating Ring Gear
- Brake: Gearbox Mounted, Proportional Friction Brake System
- Drum: Diameter/Length 63.5mm x 244mm
- Mounting Bolt Pattern: 254mm x 114mm
- Rope: 10.3mm x 25m Wire Rope
- Fairlead: Stainless Steel Roller Fairlead
- Recommend Battery: 650CCA minimum
- Battery Leads: 1850mm
- Finish: Black Powder Coat
- Mechanical Warranty: Limited Lifetime
- Electrical Warranty: 7 years
- Waterproof Rating: IP67
- Certification: CE, IP67
- Winch Weight: 48kg

Performance specifications

1st Layer of Drum

Load (kg/lb)	Line Speed (mpm/fpm)	Motor Current (amps)
No load	16/52.4	47
1816/4000	3.2/10.5	180
2724/6000	2.4/7.9	230
3632/8000	1.9/6.2	280
4540/10000	1.5/4.9	320
5443/12000	1/3.3	420

Pull by Layer - Wire Rope

Layer	kg/lb	Total Rope on Drum (m/ft)
1	5443/12000	4.7/15.4
2	4195/9250	10.8/35.4
3	3413/7525	17.2/56.4
4	2877/6343	25/82.0

REVO WINCH ACCESSORIES & SPARE PARTS

SYNTHETIC ROPES

Part No: Various
RRP: From \$324.50



Bushranger REVO Synthetic Rope, for use on the Bushranger REVO Synthetic winches.

Specifications

- Synthetic Rope with black sleeve and eyelet.

Part no.	Description	RRP
RWRA004	10mm x 28m 10,000lb	\$324.50
RWRA011	11mm x 24mm 12,000lb	\$355.00

WIRE ROPE

Part No: RWRA001
RRP: \$148.50



Bushranger REVO Wire Winch Rope, for use on the Bushranger REVO Wire winch.

Part no.	Description	RRP
RWRA001	9.2mm x 28m 10,000lb	\$148.50
RWRA012	10.3mm x 24mm 12,000lb	\$159.50

WINCH ACCESSORIES

Part no.	Description	RRP
RWRA003	3/8 hook chrome for wire rope	\$16.50
RWRA006	SLR-333 Hook (chrome)	\$33.00
RWRA007	Pull strap - black with yellow writing	\$3.30
RWRA008	Hand controller - wired +5m lead	\$55.00
RWRA009	Hand controller - wireless + 5m lead	\$104.50
RWRA010	Control box, complete	\$324.50
RWRA013	1/2 Clevis Hook, suits 12,000lb wire	\$25.00

HAWSE FAIRLEAD, SYNTHETIC WINCH

Part No: RWRA005
RRP: \$88



Features

- Innovative two position and light weight Hawse Fairlead.
- Constructed from aircraft grade aluminium
- In-line and Offset mounting positions in the one product allows for greater flexibility for installations.
- Suitable for use on 10,000 or 12,000 REVO Winches and other brand winches.

Specifications

- Includes: Hawse Fairlead, mounting hardware.
- Weight: 870 grams
- Dimensions: 293mm (L) x 73mm (H) x 23mm (D)

ROLLER FAIRLEAD

Part No: RWRA002
RRP: \$104.50



Bushranger REVO Roller Fairlead, for use on the Bushranger REVO 10,000lb or 12,000lb Wire winch.

Specifications

- Stainless Steel Roller Fairlead
- Suitable for the 10,000lb or 12,000lb REVO Winch



RRP subject to change. Listed recommended retail prices are for the Australian Domestic Market.

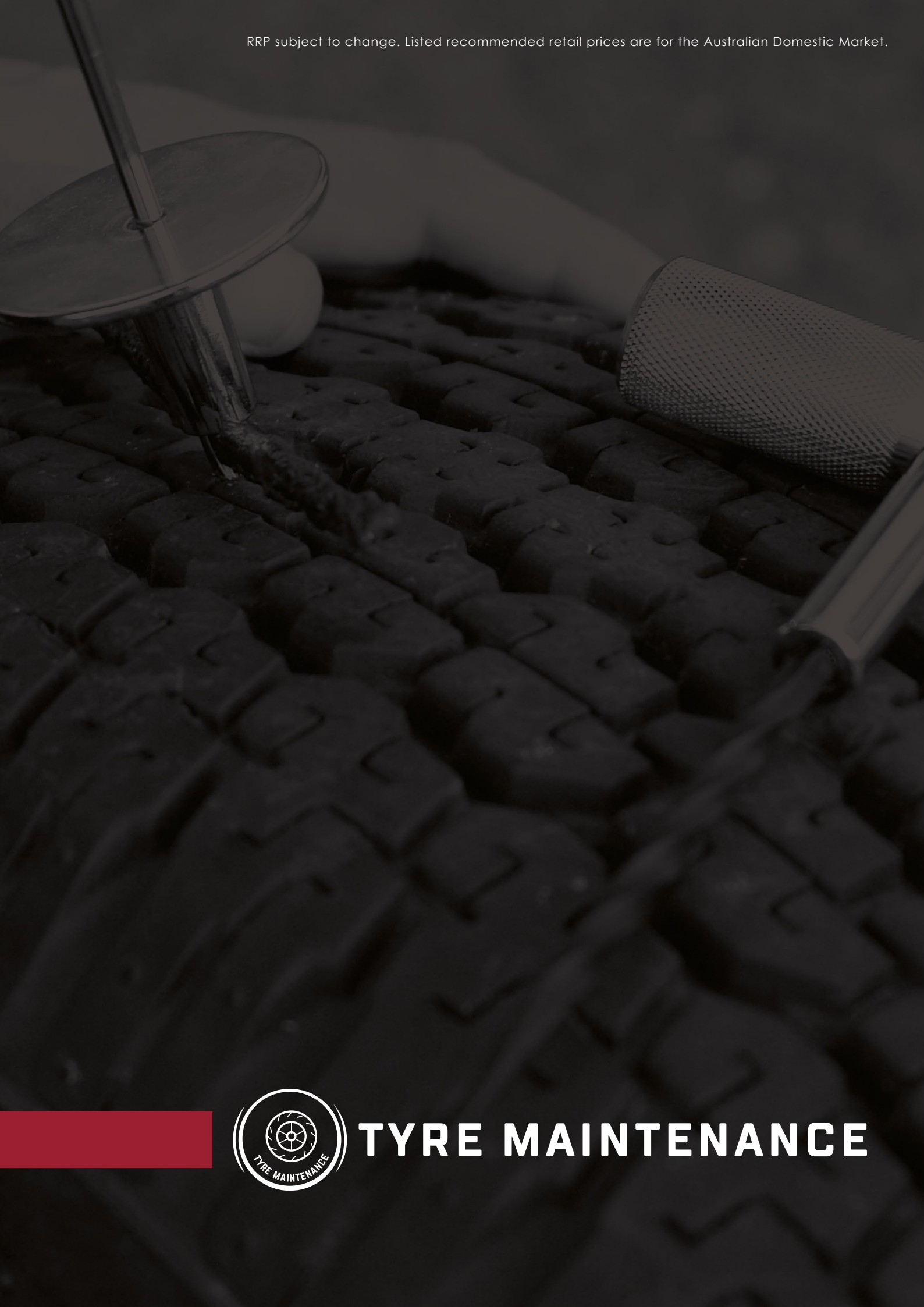

TYRE MAINTENANCE

TYRE DEFLATOR AND GAUGE

Part No: 73X31
RRP: \$31.90



Features

- Accurately read tyre pressures, and control deflations on your vehicles tyres.
- Deflation toggled continuous & intermittent.
- Easy to read dial
- Warranty: 1 year

DIAL TYRE GAUGE

Part No: 73X32
RRP: \$14.50



Features

- Accurately read tyre pressures, and control inflation in all vehicle applications including cars, motorcycles, bicycles and inflatables
- Warranty: 1 year

DIGITAL TYRE GAUGE

Part No: 73X03/N
RRP: \$29.95



Features

- For control and accuracy for all inflation and deflation
- Large backlit LCD display unit with pocket clip and rubber seal
- Accurate to 0.5 psi, reads psi, bar, kPa.
- Removable Batteries for easy replacement, and auto switch off.
- Warranty: 1 year

TYRE REPAIR KIT

Part No: 73X12B
RRP: \$18.70



Features

- Repairs punctures caused by nails, spikes or other road debris, without having to remove the tyre from the wheel.
- Kit includes: spiral hole cleaning tool, eyelet repair strip inserting tool, 5 x 7" black repair strips, 3 x 5" brown repair strips, repair strip trimming knife, tube repair strip glue.
- Warranty: 1 year

TYRE REPAIR CORDS

Part No: 73X14/A
RRP: \$7.70



Features

- 10 x 4" black tyre repairs cords.
- Suits: Plugga III and most tubeless tyre repair kits.

PLUGGA III

Part No: 73X12/P
RRP: \$39



An essential kit for every vehicle both on and off road. Repairs punctures caused by nails, spikes or other road debris, without having to remove the tyre from the wheel.

Specifications

- Includes: Reaming tool, plug insertion needle with metal stop, replacement insertion needle and allen key, long nose pliers, plug trimming knife, pencil tyre gauge, pot of plug lubricant, tyre valve replacement cores, tyre valve repair tool, 20 repair plugs, storage case.
- Weight: 1.7kg
- Warranty: 1 Year

RRP subject to change. Listed recommended retail prices are for the Australian Domestic Market.

NIGHT HAWK

NIGHT HAWK

BLUISHRANGER
4x4 GEAR



LIGHTS

NIGHT HAWK

VLI
SERIES

VARIABLE LIGHT INTENSITY

VOTED
NO 1
LED LIGHT
BY 4x4 AUSTRALIA



Bushranger® Night Hawk VLI Series LED Driving Lights have been developed from the ground up by our team of engineers to offer a truly unique design which takes performance, looks and usability to a whole new level.

The bold, modern aesthetic incorporates clever cooling ducts which channel cool air directly over the heatsink to greatly increase the heat dissipation of the LED's. The Advanced Temperature Control System takes advantage of the superior cooling design to run the LED's at their maximum potential by monitoring and adjusting the output according to the environment.

These lights are so bright, we've also incorporated a brightness control function, which allows complete control of the light intensity in conditions where too much light can be detrimental to clear vision. The brightness is controlled by our pioneering, relay-free VLI Series Wiring System, which is the first of its kind and leads the way with simpler wiring, easier installation, more user control and greater reliability over traditional systems.

Each light is supplied with two protective covers which allow the user to change the beam pattern quickly and easily. With the spot protective cover fitted, the light projects a clean, focused spot beam pattern which reaches extreme distance; great for highway driving. Clip on the flood protective cover and the light changes significantly to a wide, flood beam pattern which illuminates all the surroundings for excellent short to medium distance vision.

Bushranger® Night Hawk lights are engineered tough to withstand the rugged outdoor terrain and harsh climate experienced down under. They are backed by a 5 year warranty and our 40+ year history of supplying quality engineered 4x4 products to the Australian market.

The VLI Series 9" lights took out the No.1 spot in 4x4 Australia Magazine's, LED Driving Light Comparison Test. Up against the top 10 lights in the market, Bushranger Night Hawk VLI Series LED Driving Lights came out on top. If you're in the market for some new driving lights, the 16-page article is worth a read. You'll be sure to learn a thing or two about LED lighting and get the most from your set up. [April 2019, 4x4 Australia]

NIGHT HAWK 9" LED DRIVING LIGHTS

Part Number: NHX230VLI
RRP: \$447.50



Features

- Durable exterior | hard coated polycarbonate lens offers long term scratch resistance ensuring maximum optical efficiency for years to come. UV stable AkzoNobel powder coat, polycarbonate lens and covers ensure long term durability.
- Built tough | pressure die-cast aluminium housing and strong, 4mm thick steel bracket will handle even the toughest tracks.
- High output osram led's | 19 genuine, high output OSRAM LED's for unmatched performance. 85W and 6,450 effective lumens per light.
- Modern electronics design | built in Transistor switching simplifies wiring installation by removing the need for traditional 12V relays. PWM dimming capability for brightness control at the turn of a dial. (Wiring system sold separately)
- Sealed tight | waterproof and submersible, IP67 & IP69K rated with Genuine GORE breather, to manage the internal air pressure of the light.
- Active temperature control system | intelligent onboard monitoring of the LED temperatures, combined with the superior cooling design allows for maximum output in all conditions.
- Superior cooling design | large air intakes channel cool air over the heatsink for unmatched cooling efficiency, allowing for the use of higher-powered LED's.
- Lightweight design | compact in size, weighing just 1.7kg. Perfectly suited to nudge bar, and alternative installations where size and weight restrictions apply.
- Changeable beam pattern | clip on/clip off protective covers allow for quick changes between beam patterns. 1 x Spot, 1 x Flood included.

Specifications

- Power: 175W
- Current Draw: 12.2A @ 14.4V
- Voltage Range: 10 – 30VDC
- LED Type: 37 x Genuine OSRAM LED's
- Luminous Flux: 10,800 lumens (effective)
- Colour Temperature: 5700K
- Power Plug: Deutsch DTP
- Control Plug: 4 pin custom (use with VLI Series Wiring System, sold separately)
- Weight: 3.1kg
- Compliance: CE, UNECE R10, IP67, IP69K, ROH
- Warranty: 5 years

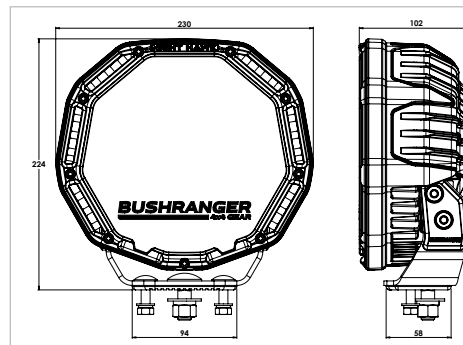

Light Performance

SINGLE LIGHT

	Spot	Flood
Max distance @ 1 lux	950m	463m
Max width @ 1 lux	52m	141m

PAIR OF LIGHTS

	Spot	Spot + Flood	Flood
Max distance @ 1 lux	1342m	1035m	636m
Max width @ 1 lux	74m	147m	200m

NIGHT HAWK 9" LED DRIVING LIGHTS

ISOLUX DATA

All results shown below are obtained from real scientific testing carried out by a NATA Accredited Photometric Laboratory in Australia.

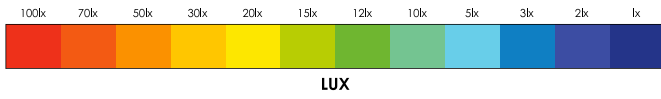

Single Light - Spot Beam (using spot cover)

Max distance @ 1lux = 950m | Max Beam Width @ 1lux = 52m

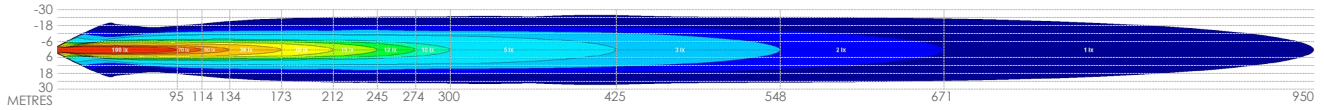

Single Light - Flood Beam (using flood cover)

Max distance @ 1lux = 463m | Max Beam Width @ 1lux = 141m

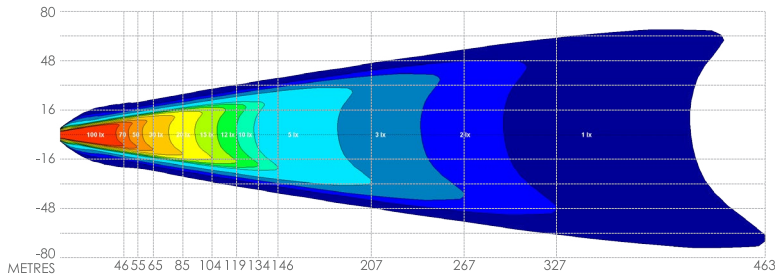

Pair Of Lights - Spot Beam Covers

Max distance @ 1lux = 1342m | Max Beam Width @ 1lux = 74m

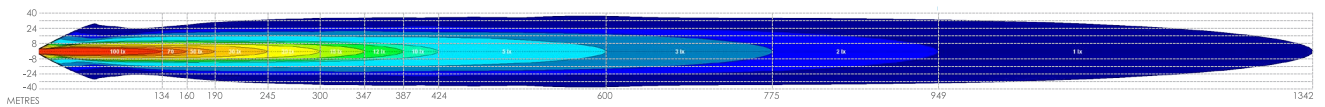

Pair Of Lights - 1 x Spot Beam Cover + 1 x Flood Beam Cover

Max distance @ 1lux = 1035m | Max Beam Width @ 1lux = 147m

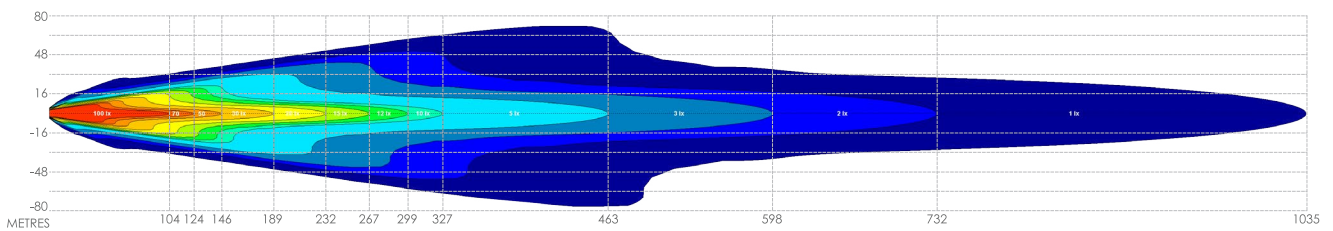

Pair Of Lights - 2 x Flood Beam Covers

Max distance @ 1lux = 636m | Max Beam Width @ 1lux = 200m

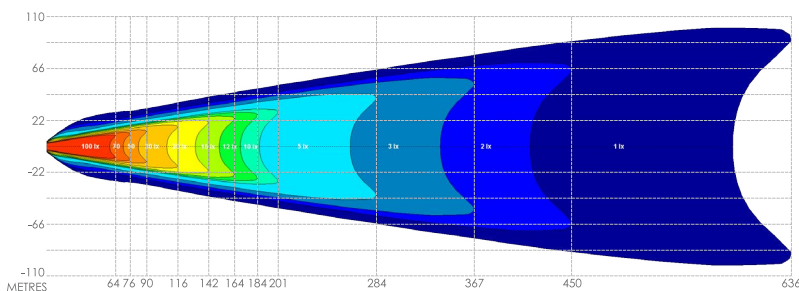

NIGHT HAWK 7" LED DRIVING LIGHTS

Part Number: NHX180VLI
RRP: \$320



Features

- Durable exterior | hard coated polycarbonate lens offers long term scratch resistance ensuring maximum optical efficiency for years to come. UV stable AkzoNobel powder coat, polycarbonate lens and covers ensure long term durability.
- Built tough | pressure die-cast aluminium housing and strong, 4mm thick steel bracket will handle even the toughest tracks.
- High output osram led's 19 genuine, high output OSRAM LED's for unmatched performance. 85W and 6,450 effective lumens per light.
- Modern electronics design | built in Transistor switching simplifies wiring installation by removing the need for traditional 12V relays. PWM dimming capability for brightness control at the turn of a dial. (Wiring system sold separately)
- Sealed tight | waterproof and submersible, IP67 & IP69K rated with Genuine GORE breather, to manage the internal air pressure of the light.
- Active temperature control system | intelligent onboard monitoring of the LED temperatures, combined with the superior cooling design allows for maximum output in all conditions.
- Superior cooling design | large air intakes channel cool air over the heatsink for unmatched cooling efficiency, allowing for the use of higher-powered LED's.
- Lightweight design | compact in size, weighing just 1.7kg. Perfectly suited to nudge bar, and alternative installations where size and weight restrictions apply.
- Changeable beam pattern | clip on/clip off protective covers allow for quick changes between beam patterns. 1 x Spot, 1 x Flood included.

Specifications

- Power: 85W
- Current Draw: 5.9A @ 14.4V
- Voltage Range: 10 – 30VDC
- LED Type: 19 x Genuine OSRAM LED's
- Luminous Flux: 6,450 lumens (effective)
- Colour Temperature: 5700K
- Power Plug: Deutsch DTP
- Control Plug: 4 pin custom (use with VLI Series Wiring System, sold separately)
- Weight: 1.7kg
- Compliance: CE, UNECE R10, IP67, IP69K, ROHS
- Warranty: 5 years

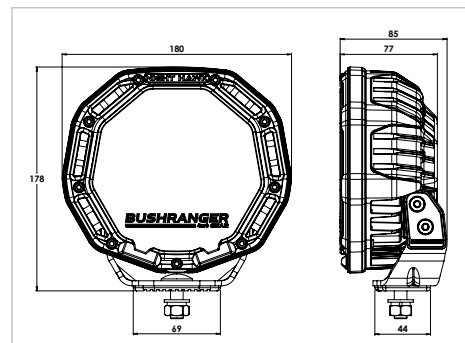

Light Performance

SINGLE LIGHT

	Spot	Flood
Max distance @ 1 lux	684m	353m
Max width @ 1 lux	43m	108m

PAIR OF LIGHTS

	Spot	Spot + Flood	Flood
Max distance @ 1 lux	967m	748m	498m
Max width @ 1 lux	60m	110m	153m

NIGHT HAWK 7" LED DRIVING LIGHTS

ISOLUX DATA

All results shown below are obtained from real scientific testing carried out by a NATA Accredited Photometric Laboratory in Australia.

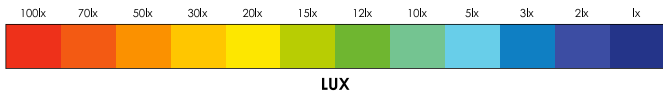

Single Light - Spot Beam (using spot cover)

Max distance @ 1lux = 684m | Max Beam Width @ 1lux = 43m

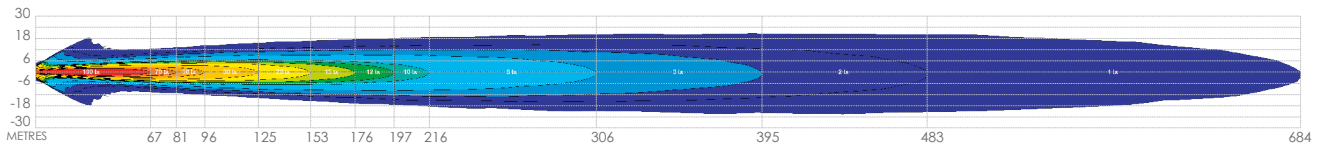

Single Light - Flood Beam (using flood cover)

Max distance @ 1lux = 353m | Max Beam Width @ 1lux = 108m

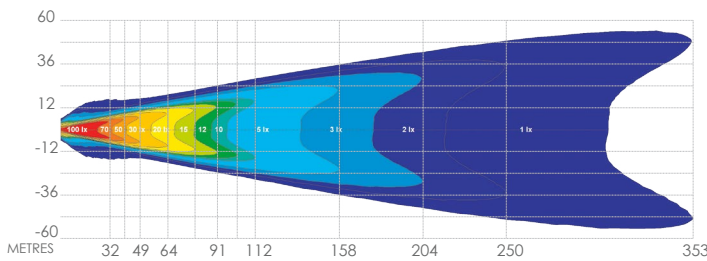

Pair Of Lights - Spot Beam Covers

Max distance @ 1lux = 967m | Max Beam Width @ 1lux = 60m

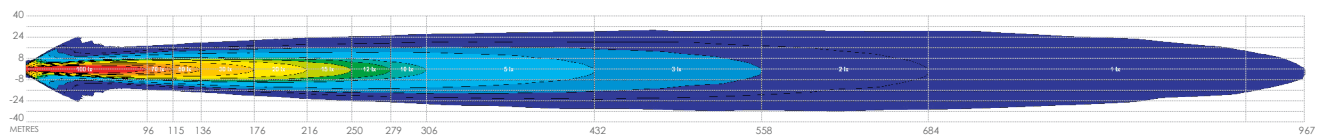

Pair Of Lights - 1 x Spot Beam Cover + 1 x Flood Beam Cover

Max distance @ 1lux = 748m | Max Beam Width @ 1lux = 110m

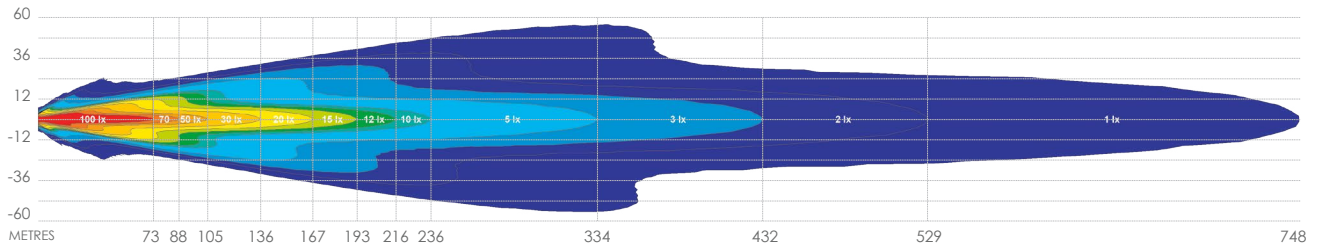

Pair Of Lights - 2 x Flood Beam Covers

Max distance @ 1lux = 498m | Max Beam Width @ 1lux = 153m

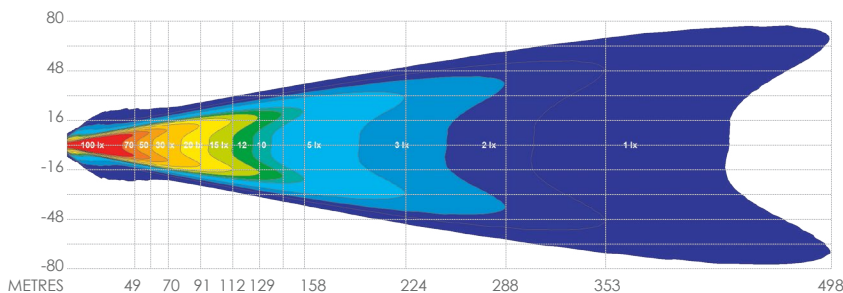

NIGHT HAWK VLI LED LIGHT BARS

Part Number: NHTVLI Series
RRP: Various



Features

- Durable exterior | UV stable polyester powder coat, polycarbonate lens and covers ensure long term durability to handle even the toughest Australian conditions.
- Built tough | Extruded, 6061 aircraft grade aluminium housing and cast alloy mounting feet offers long term strength and durability.
- High output osram led's | genuine, high output OSRAM LED's for unmatched performance.
- Modern electronics design | Built in Transistor switching simplifies wiring installation by removing the need for traditional 12V relays. PWM dimming capability for brightness control at the turn of a dial. (Wiring system sold separately)
- Active temperature control system | Intelligent on-board monitoring of the LED temperatures, combined with the superior cooling design allows for maximum output in all conditions.
- Versatile installation | Lightweight and a low-profile design with highly adjustable sliding mounting feet allow for diverse fitment.
- Changeable beam pattern | Full set of clip on/clip off spot beam and flood beam protective covers allows

Specifications

- Voltage Range: 10-30VDC
- LED Type: Genuine OSRAM LED's
- Colour Temperature: 5700K
- Control Plug: 4 pin custom (use with VLI Wiring System, sold separately)
- Colour Temperature: 5700K
- Compliance: CE, UNECE R10, IP67, IP69K, ROHS
- Warranty: 5 years

Part no.	Description	RRP
NHT055VLI	5.5" VLI Series LED Light Bar	\$115.01
NHT130VLI	13" VLI Series LED Light Bar	\$215.00
NHT170VLI	17" VLI Series LED Light Bar	\$230.00
NHT205VLI	20.5" VLI Series LED Light Bar	\$275.00
NHT245VLI	24.5" VLI Series LED Light Bar	\$315.00
NHT280VLI	28" VLI Series LED Light Bar	\$355.00
NHT320VLI	32" VLI Series LED Light Bar	\$385.00
NHT395VLI	39.5" VLI Series LED Light Bar	\$470.00
NHT435VLI	43.5" VLI Series LED Light Bar	\$520.00
NHT510VLI	51" VLI Series LED Light Bar	\$595.00

Part Number	Size	Full set of Spot Covers		Full set of Flood Covers	
		Max Distance @ 1lux	Max Primary Beam Width @ 1lux	Max Distance @ 1lux	Max Primary Beam Width @ 1lux
NHT055VLI	5.5"	267m	15m	126m (with Flood Cover) 43m (with Diffused Cover)	39m (with Flood Cover) 20m (with Diffused Cover)
NHT130VLI	13"	462m	26m	218m	69m
NHT170VLI	17"	534m	30m	252m	79m
NHT205VLI	20.5"	597m	34m	282m	89m
NHT245VLI	24.5"	654m	38m	309m	96m
NHT280VLI	28"	706m	40m	334m	105m
NHT320VLI	32"	755m	43m	357m	112m
NHT395VLI	39.5"	844m	48m	399m	125m
NHT435VLI	43.5"	886m	51m	418m	132m
NHT510VLI	51"	963m	55m	454m	143m

NIGHT HAWK VLI LED LIGHT BAR

ISOLUX DATA

NHT055VLI (5.5") – Spot beam (no cover fitted)

Max distance @ 1lux = 267m | Max Primary Beam Width @ 1lux = 15m

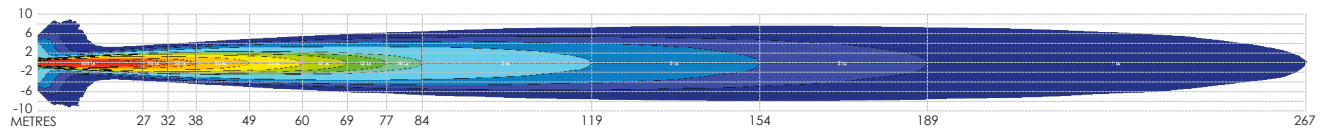

NHT055VLI (5.5") – 1 x Flood cover

Max distance @ 1lux = 126m | Max Primary Beam Width @ 1lux = 39m

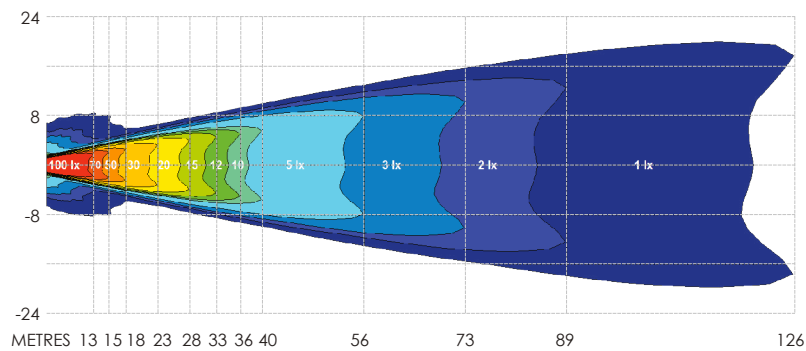

NHT055VLI (5.5") – 1 x Diffused cover

Max distance @ 1lux = 43m | Max Primary Beam Width @ 1lux = 20m

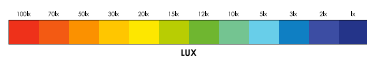
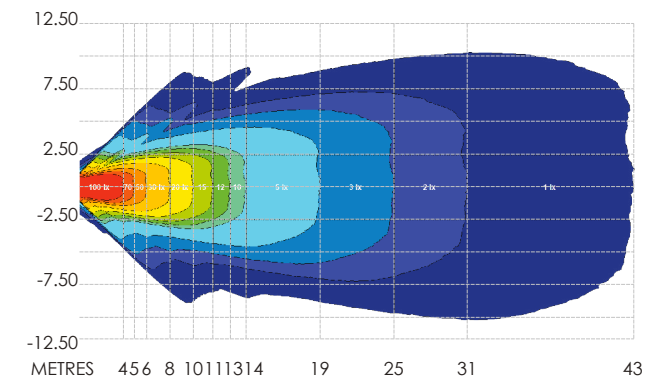

ACTUAL PHOTOMETRIC TEST DATA
PERFORMED BY NATA
ACCREDITED LABORATORY
IN AUSTRALIA

All results shown below are obtained from real scientific testing carried out by a NATA Accredited Photometric Laboratory in Australia.

NIGHT HAWK VLI LED LIGHT BAR

ISOLUX DATA

NHT130VLI (13") – 3 x Spot beam covers

Max distance @ 1lux = 462m | Max Primary Beam Width @ 1lux = 26m

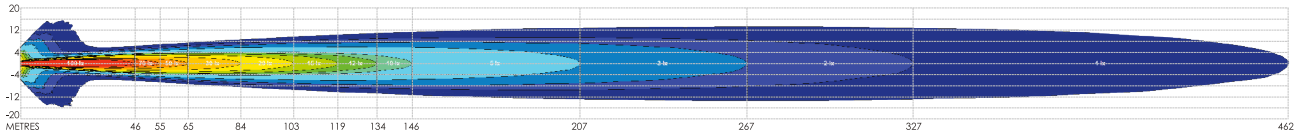

NHT130VLI (13") – 3 x Flood beam covers

Max distance @ 1lux = 218m | Max Primary Beam Width @ 1lux = 69m

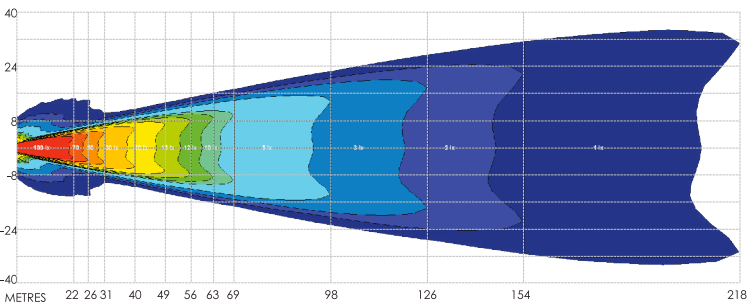

NHT170VLI (17") – 4 x Spot beam covers

Max distance @ 1lux = 534m | Max Primary Beam Width @ 1lux = 30m

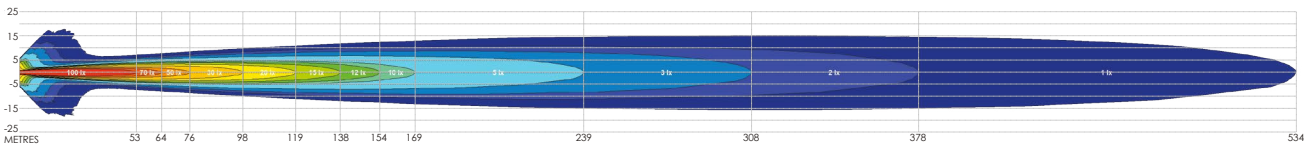

NHT170VLI (17") – 4 x Flood beam covers

Max distance @ 1lux = 252m | Max Primary Beam Width @ 1lux = 79m

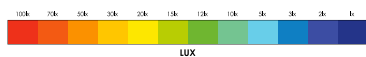
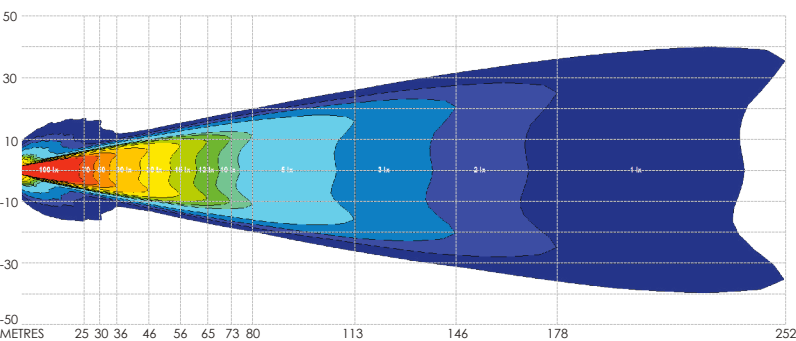

ACTUAL PHOTOMETRIC TEST DATA PERFORMED BY NATA ACCREDITED LABORATORY IN AUSTRALIA

All results shown below are obtained from real scientific testing carried out by a NATA Accredited Photometric Laboratory in Australia.

NIGHT HAWK VLI LED LIGHT BAR

ISOLUX DATA

NHT205VLI (20.5") – 5 x Spot beam covers

Max distance @ 1lux = 597m | Max Primary Beam Width @ 1lux = 34m

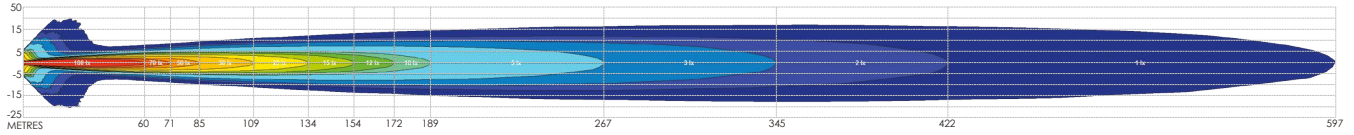

NHT205VLI (20.5") – 5 x Flood beam covers

Max distance @ 1lux = 282m | Max Primary Beam Width @ 1lux = 89m

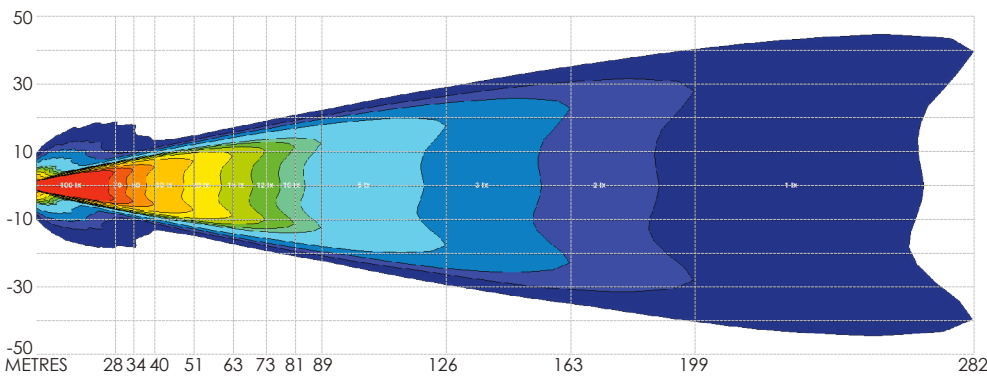

NHT245VLI (24.5") – 6 x Spot beam covers

Max distance @ 1lux = 654m | Max Primary Beam Width @ 1lux = 38m

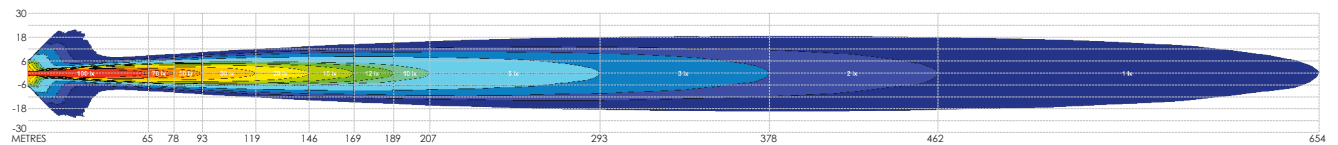

NHT245VLI (24.5") – 6 x Flood beam covers

Max distance @ 1lux = 309m | Max Primary Beam Width @ 1lux = 96m

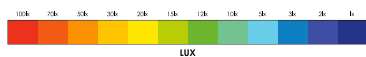
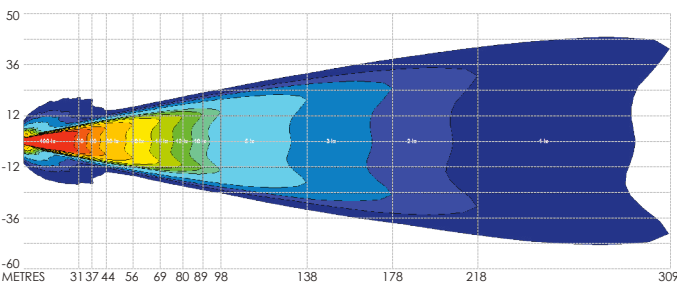

All results shown below are obtained from real scientific testing carried out by a NATA Accredited Photometric Laboratory in Australia.

RECOVERY
TYRE MAINTENANCE
LIGHTS
COMPRESSORS
CAMPING
VEHICLE PROTECTION
SIDE STEPS
WINDOWS

NIGHT HAWK VLI LED LIGHT BAR

ISOLUX DATA

NHT280VLI (28") – 7 x Spot beam covers

Max distance @ 1lux = 706m | Max Primary Beam Width @ 1lux = 40m

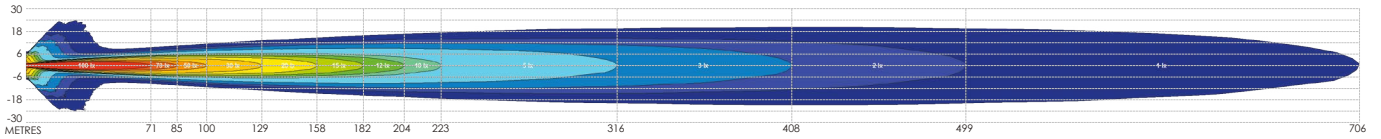

NHT280VLI (28") – 7 x Flood beam covers

Max distance @ 1lux = 334m | Max Primary Beam Width @ 1lux = 105m

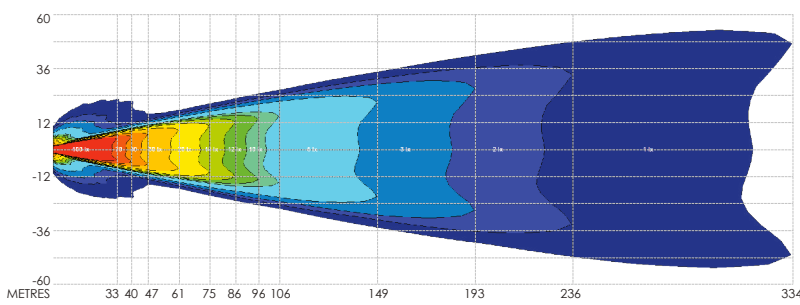

NHT320VLI (32") – 8 x Spot beam covers

Max distance @ 1lux = 755m | Max Primary Beam Width @ 1lux = 43m

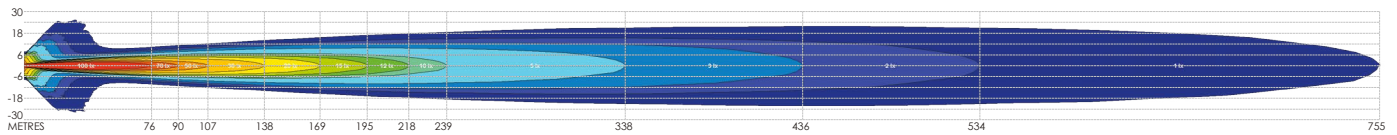

NHT320VLI (32") – 8 x Flood beam covers

Max distance @ 1lux = 357m | Max Primary Beam Width @ 1lux = 112m

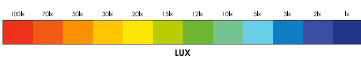
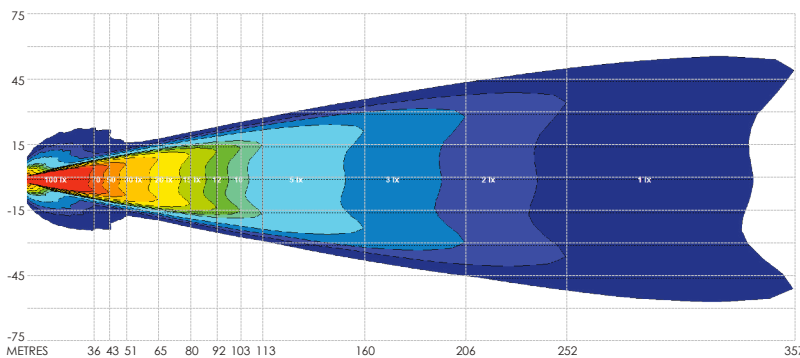

ACTUAL PHOTOMETRIC TEST DATA
PERFORMED BY NATA
ACCREDITED LABORATORY
IN AUSTRALIA

All results shown below are obtained from real scientific testing carried out by a NATA Accredited Photometric Laboratory in Australia.

NIGHT HAWK VLI LED LIGHT BAR

ISOLUX DATA

NHT395VLI (39.5") – 10 x Spot beam covers

Max distance @ 1lux = 844m | Max Primary Beam Width @ 1lux = 48m

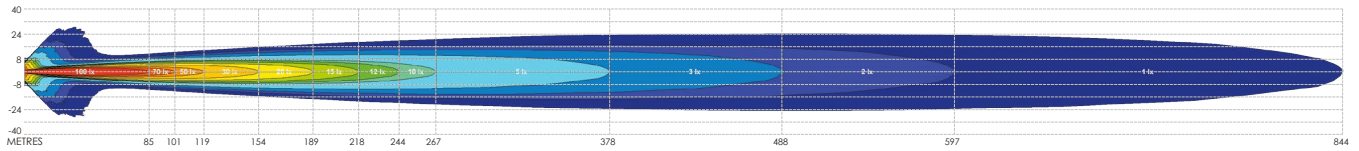

NHT395VLI (39.5") – 10 x Flood beam covers

Max distance @ 1lux = 399m | Max Primary Beam Width @ 1lux = 125m

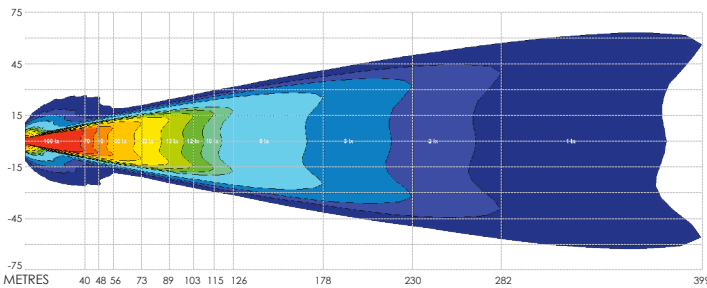

NHT435VLI (43.5") – 11 x Spot beam covers

Max distance @ 1lux = 886m | Max Primary Beam Width @ 1lux = 51m

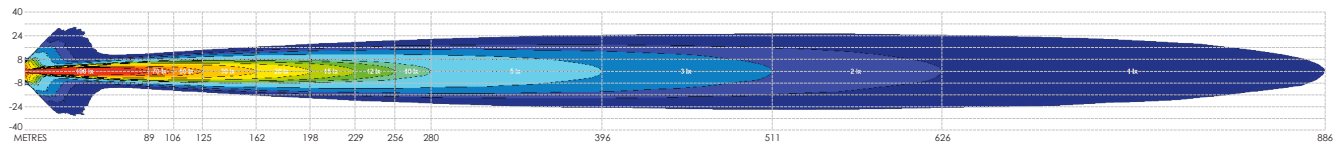

NHT435VLI (43.5") – 11 x Flood beam covers

Max distance @ 1lux = 418m | Max Primary Beam Width @ 1lux = 132m

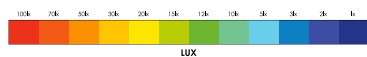
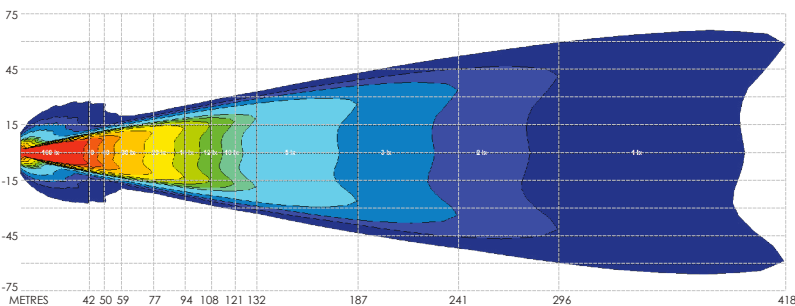

ACTUAL PHOTOMETRIC TEST DATA
PERFORMED BY NATA
ACCREDITED LABORATORY
IN AUSTRALIA

All results shown below are obtained from real scientific testing carried out by a NATA Accredited Photometric Laboratory in Australia.

NIGHT HAWK VLI LED LIGHT BAR

ISOLUX DATA

NHT510VLI (51") – 13 x Spot beam covers

Max distance @ 1lux = 963m | Max Primary Beam Width @ 1lux = 55m

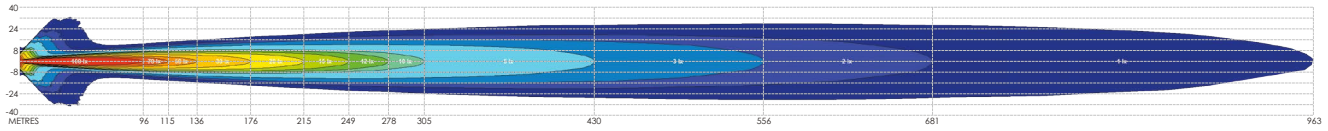

NHT510VLI (51") – 13 x Flood beam covers

Max distance @ 1lux = 454m | Max Primary Beam Width @ 1lux = 143m

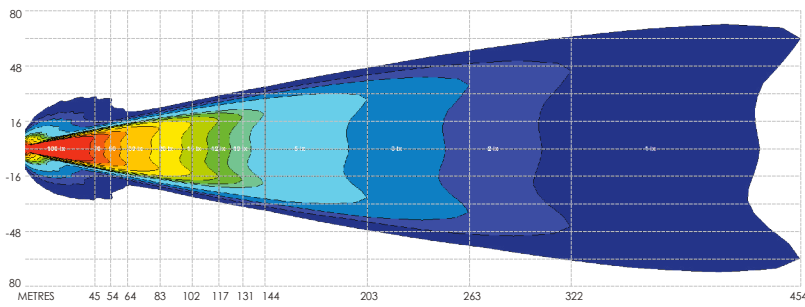

NATA ACTUAL PHOTOMETRIC TEST DATA
PERFORMED BY NATA
ACCREDITED LABORATORY
IN AUSTRALIA

All results shown below are obtained from real scientific testing carried out by a NATA Accredited Photometric Laboratory in Australia.

NIGHT HAWK VLI SERIES WIRING SYSTEM

Part No: NHW20VLI
RRP: \$89.00

Features

- Plug & Play Connectors | Control leads with waterproof plugs which quickly and easily join together to allow plenty of flexibility when routing from the control module to the VLI lights.
- Soft Start Programming | Gradually increases the light intensity over the first second of operation to reduce eye strain and flash blindness. It also extends the life of the electronics by reducing the sudden shock load.
- PWM Brightness Control | Pulse Width Modulation (PWM) signal to control the brightness of all VLI series lights. It allows the option of 7 x brightness settings.

Specifications

- Voltage: 10-30VDC
- Standby current draw: 20mA
- Light capacity (as supplied): Connect and control up to 2 x VLI series lights simultaneously
- Light capacity (max): Connect and control up to 4 x VLI series lights simultaneously
- Brightness control: 7 x brightness positions + OFF position
- Trigger wire connections: 4mm Bullet connectors
- Compliance: CE, UNECE R10
- Warranty: 5 years



WIRING LOOM 260W + DEUTSCH PLUG

Part No: NHW260D-A
RRP: \$59.99



Bushranger® Wiring Loom kit is a quick and easy pre-assembled loom.

Specifications

- Connectors: Deutsch DT-06
- Warranty: 1 Year

WIRING LOOM 260W WITH BULLET CONNECTORS

Part No: NH320K
RRP: \$59.99



Night Hawk 260W Auxiliary Light Wiring Loom.

Specifications

- Connectors: 4mm Bullet
- Warranty: 1 Year

WIRING LOOM DEUTSCH PLUG ADAPTOR

Part No: NHW060A
RRP: \$13.75



Bushranger® Deutsch Plug Double Adaptor, suits NHW260D wiring loom.

Specifications

- Connectors: Deutsch DT-06
- Warranty: 1 Year

NIGHT HAWK LIGHT ACCESSORIES

Part no.	Description	RRP
NHWA01L15	Control Lead - 1.5m	\$10.95
NHWA01L30	Control Lead - 3.0m	\$11.95
NHWA02HB3	HB3 Headlight Adaptor	\$11.95
NHWA02H4	H4 Headlight Adaptor	\$11.95

Part no.	Description	RRP
NHWA02D23	Nissan Navara D23 NP300 LED Headlight Adaptor	\$24.95
NHWA03FTM	Fuse Tap - Mini Fuse	\$7.95
NHWA03FTS	Fuse Tap - Standard Fuse	\$7.95

DRIVING LIGHT PROTECTIVE COVERS

Part No: Various
RRP: Various

Spot & flood beam cover, clear or amber.

Specifications

- Unit: pair
- Suits: Night Hawk 9" & 7" VLI Driving Lights
- Warranty: 1 year

Part no.	Description	RRP
NHX180ACCLS	Clear (Spot) to suit NHX180 lights	\$17.50
NHX180ACCLF	Clear (Flood) to suit NHX180 lights	\$17.50
NHX180ACORS	Amber (Spot) to suit NHX180 lights	\$17.50
NHX180ACORF	Amber (Flood) to suit NHX180 lights	\$17.50
NHX230ACCLS	Clear (Spot) to suit NHX230 lights	\$19.95
NHX230ACCLF	Clear (Flood) to suit NHX230 lights	\$19.95
NHX230ACORS	Amber (Spot) to suit NHX230 lights	\$19.95
NHX230ACORF	Amber (Flood) to suit NHX230 lights	\$19.95



LIGHT BAR PROTECTIVE COVERS

Part No: Various
RRP: Various

Clear diffused beam, sold in a pair. Spot and flood covers are sold separately. To suit NHT and NHS light bars.

Warranty: 1 year

Part no.	Description	RRP
NHTA01CCLS	Clear, spot, pair	\$7.95
NHTA01CCLF	Clear, flood, pair	\$11.95
NHTA01CCLD	Clear, diffused, pair	\$11.95
NHTA01CORS	Amber, spot, pair	\$7.95
NHTA01CORF	Amber, flood, pair	\$11.95
NHTA01CORD	Amber, diffused, pair	\$11.95
NHSA01CBK	Black, single	\$7.50
NHSA02CBK	Large, black, pair	\$11.00

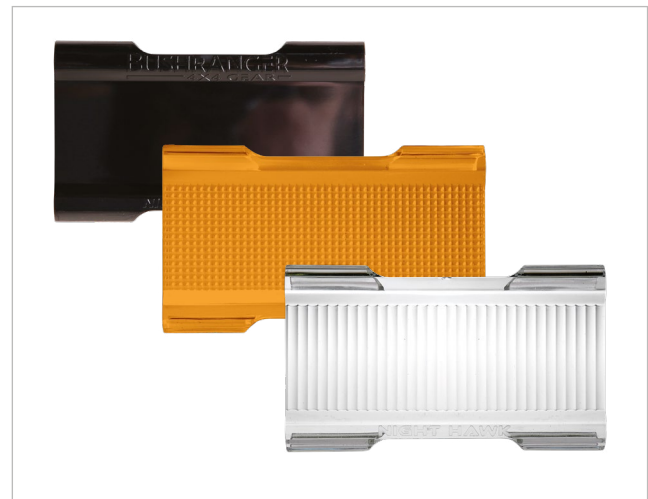

X-BAR

Part No: NH1297 | NH1297-B
RRP: from \$64.90

Bushranger® X-Bar, Number Plate Light Mounting Bar suitable for 4x4, SUV, passenger vehicles as a universal light installation solution.

Specifications

- Material: 3.2mm aluminium alloy tube. 2 x 18mm slots for easy light mounting. 1 x 16mm central aerial mounting hole. 2 x light spacers.
- Dimensions: 585mm x 111mm x 88mm
- Weight: 1.34kg
- Colour: Black or Chrome
- Suits: Driving lights, light bars and aerals
- Warranty: 5 years

Part no.	Description	RRP
NH1297	Chrome	\$75.90
NH1297-B	Black	\$64.90



TUBE CLAMP BRACKETS

Part No: NHD/NHS series
RRP: From \$55

The Bushranger® Night Hawk LED Light Bar Tube Clamps, available in four sizes, covering from 44.5mm [1.75"] to 77mm [3"] bars.

Specifications

- Colour: Black
- Unit: Pair
- Material: Extruded aluminium alloy, with UV stable black powder coat finish. Stainless steel fasteners.
- Warranty: 3 years

Part no.	Description	RRP
NHDA175TC	44.5-48mm (1.75") black, extended	\$65.00
NHDA200TC	49-51mm (2") black, extended	\$65.00
NHDA250TC	60-63.5mm (2.5") black, extended	\$70.00
NHDA300TC	75-77mm (3"), black, extended	\$70.00
NHSA175TC	44.5-48mm (1.75"), black	\$55.00
NHSA200TC	49-51mm (2"), black	\$55.00
NHSA250TC	60-63.5mm (2.5"), black	\$59.99
NHSA300TC	75-77mm (3"), black	\$59.99



MOUNTING FOOT KIT

Part No: NHTA02MFK
RRP: \$10

Mounting foot kit to suit NHT Light Bars



RRP subject to change. Listed recommended retail prices are for the Australian Domestic Market.



COMPRESSORS

RV AIR COMPRESSOR

Part No: 55X32
RRP: \$120

Features

- Flow rate 52 LPM
- Maximum pressure: 60 psi
- Built-in pressure gauge
- Gearless direct drive motor
- 4.5m power cord with battery clamps and Inline fuse
- Built-in LED work light
- Three piece Inflation needle kit

Specifications

- Suits: For tyres up to 31": 4x4, SUV, compact, touring, passenger or motorcycle tyres.
- Flow Rate: 52 LPM
- Working pressure (max): 60 psi
- Duty cycle (max): 20 min. @ 30 psi @ 22°C
- Amp draw (max): 14.5amps
- Voltage: 12v
- Dimensions: 23cm (L) x 7.6cm (W) x 14cm (T)
- Weight: 2kg
- Warranty: 5 year



BLACK MAX COMPRESSOR

Part No: 55X12
RRP: \$250

Features

- Flow Rate: 66 LPM
- Maximum pressure: 150 psi
- 12 volt motor and air pump
- 7.5 metre coiled air hose, 9.9m reach
- Built in tyre deflation valve for controlled deflation
- Thermal overload protection
- Built-in on-off switch
- Removable rubber mounted Base-plate disperses vibration and is removable for hard mount applications.
- Robust Carry/Storage bag with additional pockets for extra items.
- Supplied with hard mount kit to permanently mount compressor, dry sump allows mounting on any angle.
- Accessories and spare parts available (sold separately)

Specifications

- Suits: 4x4, SUV, compact, touring, passenger or motorcycle tyres.
- Flow Rate: 66 LPM
- Working pressure (max): 150 psi
- Duty cycle (max): 30 min. @ 40 psi @ 24°C
- Ambient temp (max): 60 °C
- Amp draw (max): 28amps (30A fused)
- Voltage: 13.8v
- Weight: compressor 3.9kg, complete kit 4.9kg
- Warranty: 5 year



RECOVERY

TYRE MAINTENANCE

LIGHTS

COMPRESSORS

CAMPING

VEHICLE PROTECTION

SIDE STEPS

WINDOWS

MAX AIR III COMPRESSOR

Part No: 55X23

RRP: \$350

Features

- Flow rate: 72 LPM
- Maximum Pressure: 150 psi
- 12 volt motor and air pump
- Trigger style inflation gun with locking lever
- Built in deflator button on trigger
- Pressure Switch: On: 0 – 120 psi (+/- 5%) | Off: 150 psi (+/- 5%)
- Thermal overload protection
- Back-lit Large Digital Display
- Heavy Duty power lead and 40A inline fuse for compressor protection
- 2.5m power cord and 9m flexible fiber reinforced air hose with an 11.5m reach
- Built-in on-off switch
- Removable rubber mounted base-plate disperses vibration and is removable for hard mount applications
- Hard mount kit to permanently mount compressor, dry sump allows for multiple angle mounting.
- Quality manufactured and accredited to International ISO9002 Standards and conforms to AS/NZS1044
- 3 additional nozzles
- Robust Carry/Storage bag with additional pockets for extra items.
- Accessories and spare parts available (sold separately)

Specifications

- Suits: 4x4, SUV, compact, touring, passenger or motorcycle tyres.
- Flow Rate: 72 LPM
- Working pressure (max): 150 psi
- Duty cycle (max): 33% @ 100psi
- Amp draw (max): 30 amps fused
- Voltage (max): 13.8v
- Ambient temp (max): 70 °C
- Materials: Cast Alloy air pump casing with cooling fans, cast air filter and diamond plate base tray with rubber base.
- Dimensions: 290mm (L) x 190mm (H) x 150mm (W)
- Weight: compressor only 4.9kg, kit 6.5kg
- Warranty: 5 year



BUSHRANGER COMPRESSOR SPARE PARTS

Part no.	Description	RRP
73X33	Jet-set air control inflator	\$64.00
55X04	Air filter element, suits max air, 5 pack	\$7.15
55X18	Air filter element, suits super, max airll, black max, 5 pack	\$5.50
55X17	Metal air filter cases, suits super, max airll, black max	\$14.19
55X21	Hose with gauge & fittings, suits max airll, black max	\$49.83
55X19	Hose with gauge & fittings, suits super max	\$70.40
55X08	Coil air hose extension, suits max air	\$28.60
55X25	Trigger gun with lock, gauge, suits max air III	\$113.73
55X27	Air hose, suits max air III	\$55.00

AIR KIT | 1 GALLON & 275C COMPRESSOR

Part No: 1010
RRP: \$569.00

Kit includes:

- 1 x 1 Gallon 3 port Tank – 1/4"NPT
- 1 x 110/150 psi Pressure Switch
- 1 x 275c ViAir Compressor
- 1 x Illuminated Dash Panel Gauge
- 1 x 20ft Airline
- 1 x 20ft Positive Wire with Inline Fuse
- 1 x 1/4" quick coupler connector
- 1 x 18" x 1/4" Stainless Steel Braided Line with Inline Check Valve
- 2 x gauge fitting
- 1 x 3-way fitting
- 1 x 175 psi Safety Valve
- 1 x drain cock
- 2 x Blank Plugs
- 1 x Male Tee
- 1 x Reducer 1/4" to 1/8"

**Specifications**

- Air Flow : 57 litres per minute
- Voltage: 13.8V (max)
- Draw: 18A Fused (max)
- Pressure: 150 psi (max)
- Ambient Temp: 70 °C (max)
- Duty Cycle: 25% @ 100 psi (max)
- Warranty: 1 year

AIR KIT | 1 GALLON

Part No: 1010/A
RRP: \$328.90

Kit includes:

- 1 x 1 Gallon (3.78L), 3 Port Tank (Manufactured to ASNZS1200)
- 1 x Reducer 1/4" to 1/8"
- 1 x Illuminated Dash Panel Gauge
- 1 x 1/4" Quick coupler connector
- 1 x 3-way Fitting
- 1 x 175 psi Safety Valve
- 1 x Male Tee
- 1 x 110/150 psi Pressure Switch
- 1 x 20 foot (6.1m) Airline
- 1 x 20 foot (6.1m) Positive Wire with 30A Inline Fuse
- 2 x Gauge Fittings
- 1 x Drain Cock
- 2 x Blank Plugs
- Warranty: 1 year

**AIR KIT | 5 GALLON & 400C COMPRESSOR**

Part No: 1050
RRP: \$859.00

Kit includes:

- 1 x 5 Gallon (20 litre), 5 Port Tank (Manufactured to ASNZS1200)
- 1 x 110/150 psi Pressure Switch
- 1 x 400c Vi-Air Compressor
- 1 x 20 foot (6.1m) Airline
- 1 x Illuminated Dash Panel Gauge
- 1 x 20' (6.1m) Positive Wire with 30A Inline Fuse
- 1 x 1/4" Quick coupler connector
- 2 x Gauge Fittings
- 1 x 3-way Fitting
- 1 x Drain Cock
- 1 x 175 psi Safety Valve
- 2 x Blank Plugs
- 1 x Male Tee
- 1 x Reducer 1/4" to 1/8"

**Specifications**

- Air Flow : 72 litres per minute
- Voltage: 13.8V (max)
- Draw: 30A Fused (max)
- Pressure: 200 psi (max)
- Ambient Temp: 60°C (max)
- Duty Cycle: 40 mins @ 40 psi @ 24°C (max)
- Warranty: 1 year

AIR KIT | 5 GALLON

Part No: 1050/A
RRP: \$495.00

Kit includes:

- 1 x 5 Gallon (20 litre), 5 Port Tank (Manufactured to ASNZS1200)
- 1 x 110/150 psi Pressure Switch
- 1 x 20 foot (6.1m) Airline
- 1 x Illuminated Dash Panel Gauge
- 1 x 20' (6.1m) Positive Wire with 30A Inline Fuse
- 1 x 1/4" Quick coupler connector
- 2 x Gauge Fittings
- 1 x 3-way Fitting
- 1 x Drain Cock
- 1 x 175 psi Safety Valve
- 2 x Blank Plugs
- 1 x Male Tee
- 1 x Reducer 1/4" to 1/8"
- Warranty: 1 year

**AIR KIT | 5 GALLON & 2 X 400C COMPRESSOR**

Part No: 1052
RRP: \$1,375.00

Kit includes:

- 1 x 5 Gallon (20 litre), 5 Port Tank (Manufactured to ASNZS1200)
- 1 x 110/150 psi Pressure Switch
- 1 x 400c ViAir Compressor
- 1 x 20 foot (6.1m) Airline
- 1 x Illuminated Dash Panel Gauge
- 1 x 20' (6.1m) Positive Wire with 30A Inline Fuse
- 1 x 1/4" Quick coupler connector
- 2 x Gauge Fittings
- 1 x 3-way Fitting
- 1 x Drain Cock
- 1 x 175 psi Safety Valve
- 2 x Blank Plugs
- 1 x Male Tee
- 1 x Reducer 1/4" to 1/8"

**Specifications**

- Air Flow : 72 litres per minute
- Voltage: 13.8V (max)
- Draw: 30A Fused (max)
- Pressure: 200 psi (max)
- Ambient Temp: 60°C (max)
- Duty Cycle: 40 mins @ 40 psi @ 24°C (max)
- Warranty: 1 year

**AIR TANK
1 GALLON | 3 PORT**

Part No: 1048
RRP: \$192.50

On Board Air Tank, 1 Gallon,
3 port tank, 1/4" NPT

Specifications

- Diameter: 155mm
- Bracket Height: 40mm
- Dimensions: 210mm (H) x 155mm (W) x 300mm (L)
- Warranty: 1 year

**AIR TANK
5 GALLON | 7 PORT**

Part No: ABR144
RRP: \$319.00

On Board Air Tank, 1 Gallon,
3 port tank, 1/4" NPT

Specifications

- Diameter: 155mm
- Bracket Height: 40mm
- Dimensions: 210mm (H) x 155mm (W) x 300mm (L)
- Warranty: 1 year



VIAIR 275C COMPRESSOR KIT

Part No: V27520
RRP: \$248.00



Features

- Check Valve
- Vibration Isolators
- Mounting Hardware
- Stainless Steel Braided Leader Hose
- Air Line for Remote Mount Air Filter
- Remote Mount Air Filter Assembly
- 2 x Replacement Air Filter Elements
- Installation Instructions

Specifications

- Duty Cycle: 25% @ 100 PSI
- Working Pressure: 150 PSI (max)
- Air Tank Size: 2.5 Gallon (max)
- Amp Draw: 18 Amps (max)
- Ingress Protection Rating: IP54
- Dimensions: 6.5"L x 3.5"W x 4.5"H
- Weight: 5.20 lbs.
- Warranty: 1 year

VIAIR 280C COMPRESSOR KIT

Part No: V28021
RRP: \$323.40



Features

- Check Valve
- Vibration Isolators
- Mounting Hardware
- Stainless Steel Braided Leader Hose
- Direct Air Filter Assembly
- 2 x Replacement Air Filter Elements
- Installation Instructions

Specifications

- Duty Cycle: 30% @ 100 PSI
- Working Pressure: 150 PSI (max)
- Air Tank Size: 2.5 Gallon (max)
- Amp Draw: 19 Amps (max)
- Ingress Protection Rating: IP54
- Dimensions: 7.8"L x 3.95"W x 6.35"H
- Weight: 6.95 lbs.
- Warranty: 1 year

VIAIR 325C COMPRESSOR KIT | 12V

Part No: V32530
RRP: \$320.00



Features

- Check Valve
- Vibration Isolators
- Mounting Hardware
- Stainless Steel Braided Leader Hose
- Air Line for Remote Mount Air Filter
- Remote Mount Air Filter Assembly
- 2 x Replacement Air Filter Elements
- Installation Instructions

Specifications

- Duty Cycle: 33% @ 100 PSI
- Working Pressure: 150 PSI (max)
- Air Tank Size: 5 Gallon (max)
- Amp Draw: 21 Amps, 12V (max)
- Ingress Protection Rating: IP67
- Dimensions: 8"L x 4"W x 6.75"H
- Weight: 7.5 lbs.
- Warranty: 1 year

VIAIR 325C COMPRESSOR KIT | 24V

Part No: V32538
RRP: \$338.00



Features

- Check Valve
- Vibration Isolators
- Mounting Hardware
- Stainless Steel Braided Leader Hose
- Air Line for Remote Mount Air Filter
- Remote Mount Air Filter Assembly
- 2 x Replacement Air Filter Elements
- Installation Instructions

Specifications

- Duty Cycle: 33% @ 100 PSI
- Working Pressure: 150 PSI (max)
- Air Tank Size: 5 Gallon (max)
- Amp Draw: 13 Amps, 24V (max)
- Ingress Protection Rating: IP67
- Dimensions: 8"L x 4"W x 6.75"H
- Weight: 7.5 lbs.
- Warranty: 1 year

RECOVERY
TYRE MAINTENANCE
LIGHTS
COMPRESSORS
CAMPING
VEHICLE PROTECTION
SIDE STEPS
WINDOWS

VIAIR 330C COMPRESSOR KIT | 24V

Part No: V33058
RRP: \$374.50



Features

- Vibration Isolators
- Mounting Hardware
- Heavy Duty 1/4" NPT Check Valve
- Stainless Steel Braided PTFE-Lined Leader Hose
- Air Line for Remote Mount Air Filter
- Remote Mount Air Filter Assembly
- 2 x Replacement Air Filter Elements
- Installation Instructions

Specifications

- Duty Cycle: 100% @ 100 PSI
- Working Pressure: 150 PSI (max)
- Air Tank Size: 5 Gallon (max)
- Amp Draw: 9 Amps, 24V (max)
- Ingress Protection Rating: IP67
- Dimensions: 9"L x 4"W x 6.75"H
- Weight: 8.25 lbs.
- Warranty: 1 year

VIAIR 400C COMPRESSOR KIT

Part No: V40040
RRP: \$355.00



Features

- Check Valve
- Vibration Isolators
- Mounting Hardware
- Stainless Steel Braided Leader Hose
- Air Line for Remote Mount Air Filter
- Remote Mount Air Filter Assembly
- 2 x Replacement Air Filter Elements
- Installation Instructions

Specifications

- Duty Cycle: 33% @ 100 PSI
- Working Pressure: 150 PSI (max)
- Air Tank Size: 5 Gallon (max)
- Amp Draw: 28 Amps, 12V (max)
- Ingress Protection Rating: IP67
- Dimensions: 9"L x 4"W x 6.75"H
- Weight: 8.65 lbs.
- Warranty: 1 year

VIAIR 380C DUAL COMPRESSOR KIT

Part No: V38003
RRP: \$679.50



Features

- 2 x 380C Chrome Air Compressors
- 2 x Air Filter Assemblies
- 2 x Remote Mount Brackets
- 2 x Sets of Remote Mount Fittings
- 2 x Sets of Spare Air Filter Elements
- 2 x Leader Hose Clips
- 6 x Air Line Clips with Included Hardware
- 8 x Sets of Nuts, Bolts, Washers and Lock Washers
- 2 x 40-Amp Relays
- One Heavy Duty Pressure Switch (110 PSI on, 145 PSI off)
- 2 x Stainless Steel Braided

- Leader Hoses with Inline Check Valve
- Air Line (For Remote Mount Filter Installation)

Specifications

- Duty Cycle: 100% @ 100 PSI (55% @ 200 PSI)
- Working Pressure: 200 PSI (max)
- Air Tank Size: 10 Gallon (max)
- Amp Draw: 44 Amps, 12V (max)
- Ingress Protection Rating: IP67
- Dimensions: 9"L x 4"W x 6.75"H (Each Unit)
- Weight: 17.50 lbs.
- Warranty: 1 year

VIAIR 400C DUAL COMPRESSOR KIT

Part No: V40013
RRP: \$710.00



Features

- 2 x 400C Chrome Air Compressors
- 2 x Air Filter Assemblies
- 2 x Remote Mount Brackets
- 2 x Sets of Remote Mount Fittings
- 2 x Sets of Spare Air Filter Elements
- 2 x Leader Hose Clips
- 6 x Air Line Clips with Included Hardware
- 8 x Sets of Nuts, Bolts, Washers and Lock Washers
- 2 x 40-Amp Relays
- One Heavy Duty Pressure Switch (110 PSI on, 145 PSI off)
- 2 x Stainless Steel Braided Leader Hoses with Inline Check Valve

- Air Line (For Remote Mount Filter Installation)

Specifications

- Duty Cycle: 33% @ 100 PSI
- Working Pressure: 150 PSI (max)
- Air Tank Size: 10 Gallon (max)
- Amp Draw: 59 Amps, 12V (max)
- Ingress Protection Rating: IP67
- Dimensions: 9"L x 4"W x 6.75"H (Each Unit)
- Weight: 17.30 lbs.
- Warranty: 1 year

VIAIR 450C COMPRESSOR KIT | 12V

Part No: V45040
RRP: \$392.00



Features

- Check Valve
- Vibration Isolators
- Mounting Hardware
- Stainless Steel Braided Leader Hose
- Air Line for Remote Mount Air Filter
- Remote Mount Air Filter Assembly
- 2 x Replacement Air Filter Elements
- Installation Instructions

Specifications

- Duty Cycle: 100% @ 100 PSI
- Working Pressure: 150 PSI (max)
- Air Tank Size: 5 Gallon (max)
- Amp Draw: 23 Amps, 12V (max)
- Ingress Protection Rating: IP67
- Dimensions: 10.6"L x 4"W x 6.87"H
- Weight: 10.80 lbs
- Warranty: 1 year

VIAIR 450C COMPRESSOR KIT | 24V

Part No: V45058
RRP: \$442.00



Features

- Vibration Isolators
- Mounting Hardware
- Heavy Duty 1/4" NPT Check Valve
- Stainless Steel Braided PTFE-Lined Leader Hose
- Air Line for Remote Mount Air Filter
- Remote Mount Air Filter Assembly
- 2 x Replacement Air Filter Elements
- Installation Instruction

Specifications

- Duty Cycle: 100% @ 100 PSI
- Working Pressure: 150 PSI (max)
- Air Tank Size: 5 Gallon (max)
- Amp Draw: 13 Amps 24v (max)
- Ingress Protection Rating: IP67
- Dimensions: 11.25"L x 4"W x 6.75"H
- Weight: 10.40 lbs.
- Warranty: 1 year

VIAIR 460C COMPRESSOR KIT

Part No: V46043
RRP: \$625.00



Features

- Check Valve
- Vibration Isolators
- Mounting Hardware
- Stainless Steel Braided Leader Hose
- Air Line for Remote Mount Air Filter
- Remote Mount Air Filter Assembly
- 2 x Replacement Air Filter Elements
- Installation Instructions

Specifications

- Duty Cycle: 100% @ 100 PSI
- Working Pressure: 150 PSI (max)
- Air Tank Size: 5 Gallon (max)
- Amp Draw: 24 Amps 12v (max)
- Ingress Protection Rating: IP67
- Dimensions: 11.5"L x 4.3"W x 6.5"H
- Weight: 11.10 lbs.
- Warranty: 1 year

RECOVERY
TYRE MAINTENANCE
LIGHTS
COMPRESSORS
CAMPING
VEHICLE PROTECTION
SIDE STEPS
WINDOWS

VIAIR 480C COMPRESSOR KIT

Part No: V48043
RRP: \$505.00



Features

- Check Valve
- Vibration Isolators
- Mounting Hardware
- Stainless Steel Braided Leader Hose
- Air Line for Remote Mount Air Filter
- Remote Mount Air Filter Assembly
- 2 x Replacement Air Filter Elements
- Installation Instructions

Specifications

- Duty Cycle: 100% @ 100 PSI (50% @ 200 PSI)
- Working Pressure: 200 PSI (max)
- Air Tank Size: 5 Gallon (max)
- Amp Draw: 23 Amps 12v (max)
- Ingress Protection Rating: IP67
- Dimensions: 10.87"L x 4.2"W x 6.75"H
- Weight: 8.75 lbs.
- Warranty: 1 year

VIAIR 480C DUAL COMPRESSOR KIT

Part No: V48032
RRP: \$940.50



Features

- 2 x 480C Air Compressors
- 2 x Air Filter Assemblies
- 2 x Remote Mount Brackets
- 2 x Sets of Remote Mount Fittings
- 2 x Sets of Spare Air Filter Elements
- 2 x Leader Hose Clips
- 6 x Air Line Clips with Included Hardware
- 8 x Sets of Nuts, Bolts, Washers and Lock Washers
- 1 x Heavy Duty Tube Style Fuse Holder (Up to 60-Amp fuse)
- 2 x 40-Amp Relays
- 1 x Heavy Duty Pressure Switch (165 PSI on, 200 PSI off)

- 2 x Stainless Steel Braided Leader Hoses with Inline Check Valve
- 1 x Air Line (For Remote Mount Filter Installation)

Specifications

- Duty Cycle: 100% @ 100 PSI (50% @ 200 PSI)
- Working Pressure: 200 PSI (max)
- Air Tank Size: 10 Gallon (max)
- Amp Draw: 44 Amps 12v (max)
- Ingress Protection Rating: IP67
- Dimensions: 10.87"L x 4.2"W x 6.75"H (Each Unit)
- Weight: 22.10 lbs.
- Warranty: 1 year

VIAIR ADJUSTABLE TIE DOWN STRAP

Part No: V00015
RRP: \$13.75



Viair Adjustable Tie Down Strap allows you to secure your portable compressor in one place with the adjustable tie-down strap. Steel brackets and mounting hardware.

NOTE: Bag not included for display purposes only.

Warranty: 1 Year

VIAIR TYRE INFLATION GUN | ANALOGUE

Part No: V00041
RRP: \$80.85



Viair Tyre Inflation Gun reads pressures up to 200 PSI and 14 BAR. This useful tool features a normally closed air chuck that can be opened by pressing the lever on the inflation gun. Because this air chuck is normally closed, the Tire Inflation Gun is a perfect compliment to onboard air systems and VIAIR's line of "Portable Automatic" compressors. Comes with a deluxe carry bag.

Please Note: To be used on Portable Automatic compressors only. Not for use on regular portable compressors.

Warranty: 1 Year

VIAIR BSP ADAPTOR

Part No: V90001
RRP: \$5.90



Viair BSP Adaptor, x2, 1/4" NPT (M) to 1/8" BSP (F)

BRAIDED COIL HOSE

Part No: V00029
RRP: \$93.50



Braided Coil Hose with inline inflator/deflator pressure gauge, 3-piece inflation tips kit, quick connect stud, and storage bag. (25ft. hose rated to 200 PSI) For use with 300P and larger portable compressors and "H" model compressors.

VIAIR COIL AIR HOSE

Part No: V00037
RRP: \$51.15



Viair 35' Coil Air Hose with Air Chuck, 1/4" NPT, hose rated to 200psi. For direct use with an air tank.

VIAIR BLOW GUN

Part No: V00045
RRP: \$17.05



Viair Blow Gun with pre-assembled with 1/4" quick connect stud.

VIAIR ONBOARD AIR HOOKUP KIT

Part No: Various
RRP: Various



Kit includes

- (1) Illuminated Dash Panel Gauge
- (1) 20 Ft. 1/4" O.D. Air Line Tubing
- (1) Pressure Switch with Built-In Relay
- (1) 20 Ft. Lead Wire with Inline Fuse
- (1) 1/4" (F) NPT Tee Fitting
- (1) 1/4" to 1/8" NPT Reducer
- (1) 1/4" Quick Connect Coupler
- (1) 1/4" (F) NPT Quick Connect Stud
- (1) 1/4" (M) NPT Compression Fitting*
- (1) 1/4" (M) NPT Compression Tee Fitting*
- (3) Insulated (F) Terminal Connectors
- (2) Insulated (M) Terminal Connectors
- (2) Quick Splice Connectors
- (3) Ring Terminals
- (6) Cable Ties
- (3) Cable Tie Brackets
- (3) Air Line Clips
- (1) Continuous Grommet
- (2) Mounting Screws, Washers, Nuts
- (1) Instruction Manual
- * All compression fittings are for 1/8" O.D. airline.

Part no.	Description	RRP
V10051	20amp, 85/105psi	\$454.00
V20052	30amp, 110/145psi	\$196.90
V20053	30amp, 85/105psi	\$173.00

STAINLESS STEEL BRAIDED LEADER HOSES

Part No: V20052
RRP: \$196.90

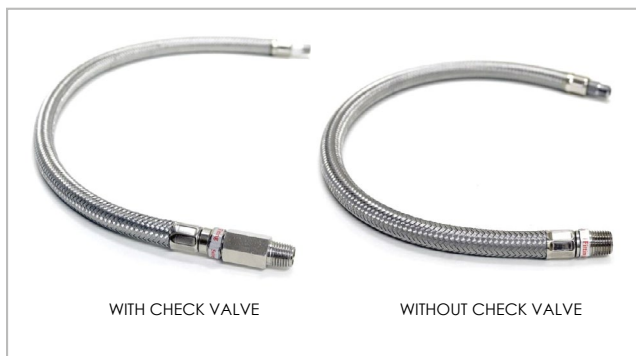

All fittings are NPT thread.

Note: Use thread sealant for proper installation. Thread tape is not recommended. Properly sealed, recommended torque for 1/8" is 10 ~ 11 ft. lbs. Recommended torque for 1/4" and 3/8" is 12 ~ 15 ft. lbs.

Part no.	Description	RRP
V92791	24", 3/8"-3/8" check valve	\$46.00
V92792	24", 3/8"-3/8" swivel	\$43.51
V92793	21", 1/4"-1/4" check valve	\$40.50
V92801	1/8" male to 1/4" female	\$24.75
V92802	1/4" male to 1/4" female	\$24.20
V92803	1/8" male to 1/4" male	\$24.20
V92804	1/4" male to 1/4" male	\$32.45
V92807	1/8" male to 1/4" male	\$39.60
V92809	1/4" male to 1/4" male swivel 36" long	\$51.15

VIAIR ILLUMINATED DASH PANEL GAUGE KIT

Part No: V20062
RRP: \$74.00



This is the same gauge used in our onboard air hookup kits. Utilising a well-designed, high quality 150 PSI or 200 PSI pressure monitor with built-in ON/OFF switch to activate or deactivate compressors as needed, this gauge kit is perfect for those who already have an onboard air setup.

VIAIR AIR TANK PORT FITTINGS KIT

Part No: V90005
RRP: \$27.50



Viair Air Tank Port Fittings Kit, 5 piece.

- (2) 1/4" NPT Plugs
- 1/4" NPT Drain Cock
- 1/4" NPT Compression Fitting
- 250 PSI Safety Valve (P/N V90004)
- 175 PSI Safety Valve (P/N V90005)

VIAIR LOCKER FITTING ADAPTOR KIT | 5 PIECE

Part No: V90006
RRP: \$22.00



Viair Air Locker Tank Port Fittings, 5 piece.

- Viair Air Locker Tank Port Fittings, 5 piece
- 2 x 1/4" NPT Plugs
- 1 x 1/4" NPT to 1/8" BSP Adaptor
- 1 x 1/4" NPT Drain Cock
- 1 x 1/4" NPT Compression fittings
- 1 x 175 PSI Safety Valve

VIAIR AIR SOURCE RELOCATION KIT

Part No: V90007
RRP: \$30.50



Viair Air Source Relocation Kit.

- 1/4" NPT (F) Quick Connect Coupler
- 1/4" NPT (F) Quick Connect Stud
- (2) 1/4" NPT Compression Fittings (For 1/4" Line)
- 15 ft. Air Line Tubing
- 3 Air Line Clips
- 5" Continuous Grommet

VIAIR NPT PLUGS KIT

Part No: V90003
RRP: \$6.09



Viair NPT Plugs Kit, 1/4" (M) NPT Recessed, 5pcs.

VIAIR INSULATED TERMINALS

Part No: V92921
RRP: \$1.65



1/4" (F) / 16 Gauge, 5pcs.

VIAIR FUSE

Part No: V92932
RRP: \$2.75

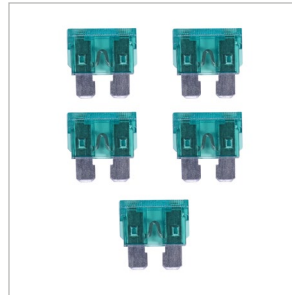

30-AMP Fuse, 5pcs.

VIAIR FUSE HOLDER

Part No: V92946
RRP: \$7.15



Viair Fuse Holder, 30 amp, 12 gauge, Moisture resistant.

RECOVERY

TYRE MAINTENANCE

LIGHTS

COMPRESSORS

CAMPING

VEHICLE PROTECTION

SIDE STEPS

WINDOWS

VIAIR FUSE HOLDER | 20-60AMP

Part No: V92952
RRP: \$19.00



Viair Fuse Holder, with mounting tabs, 20-60amp.

VIAIR RELAY | 40AMP

Part No: V93940
RRP: \$13.48



Viair Relay, 40amp, 40A-12V.

VIAIR DUAL NEEDLE GAUGE, 2"

Part No: V90080
RRP: \$81.50



Viair Dual Needle Gauge 2", 220 PSI, black face, illuminated.

VIAIR DUAL NEEDLE GAUGE, 2"

Part No: V90081
RRP: \$81.50



Viair Dual Needle Gauge, 2", 220 psi, white face, illuminated.

VIAIR DUAL NEEDLE GAUGE, 2"

Part No: V90082
RRP: \$81.50



Viair Dual Needle Gauge, 2", 160 psi, black face, illuminated.

VIAIR DUAL NEEDLE GAUGE, 2"

Part No: V90083
RRP: \$81.50



Viair Dual Needle Gauge, 2", 160 psi, white face, illuminated.

VIAIR SINGLE NEEDLE GAUGE, 1.5"

Part No: V90084
RRP: \$13.00



Viair Single Needle Gauge, 1.5", 160 psi, white face, no light.

VIAIR SINGLE NEEDLE GAUGE, 1.5"

Part No: V90085
RRP: \$13.00



Viair Single Needle Gauge, 1.5", 160 psi, black face, no light.

VIAIR SINGLE NEEDLE GAUGE, 2"

Part No: V90087
RRP: \$14.00



Viair Single Needle Gauge, 2", 160 psi, white face, illuminated.

VIAIR SINGLE NEEDLE GAUGE, 2"

Part No: V90088
RRP: \$14.00



Viair Dual Needle Gauge, 2", 160 psi, black face, illuminated.

VIAIR SINGLE NEEDLE GAUGE, 2"

Part No: V90089
RRP: \$18.00



Viair Single Needle Gauge, 2", 220 psi, white face, illuminated.

VIAIR SINGLE NEEDLE GAUGE, 2"

Part No: V90090
RRP: \$18.00

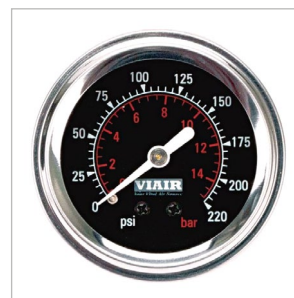

Viair Dual Needle Gauge, 2", 220 psi, black face, illuminated.

VIAIR PRESSURE SWITCH 1/8" NPT MALE PORT

Part No: Various
RRP: \$20.50

Viair Pressure Switch, 1/8" NPT Male Port. For 12-Volt and 24-Volt systems up to 20 amps.

Part no.	Description	RRP
V90100	1/8" NPT male port fitting, 90/120psi	\$20.50
V90101	1/8" NPT male port fitting, 85/105psi	\$20.50
V90102	1/8" NPT male port fitting, 110/145psi	\$20.50
V90103	1/8" NPT male port fitting, 165/200psi	\$20.50



VIAIR PRESSURE SWITCH WITH RELAY

Part No: Various
RRP: \$40.50

For 12-Volt systems only up to 40 amps. Moisture resistant and tested to last over 10,000 cycles. Leads are pre-fitted with insulated male push-to-connect terminals that are clearly marked.

Part no.	Description	RRP
V90111	110/145psi	\$40.50
V90117	140/200psi	\$42.00

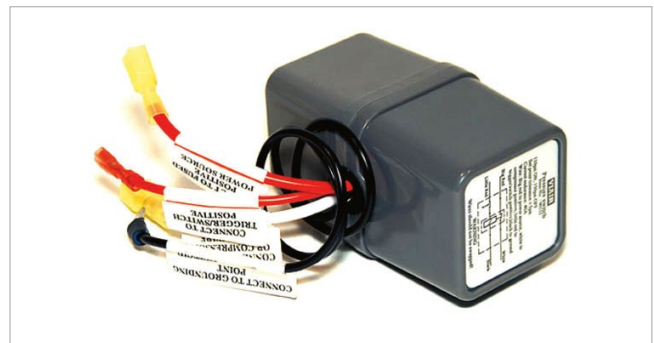

VIAIR SEALED PRESSURE SWITCHES

Part No: Various
RRP: Various

For 12-Volt and 24-Volt systems. Sealed for moisture resistance.

Part no.	Description	RRP
V90217	110/145psi	\$60.01
V90219	140/175psi	\$59.40



SAFETY VALVES

Part No: Various
RRP: Various



Part no.	Description	RRP
V92155	Safety valve, 1/4"NPT, 155psi	\$13.20
V92175	Coded safety valve, 1/4"NPT, 175psi	\$11.00
V92250	Coded safety valve, 250psi	\$11.00

AIR FILTERS

Part No: Various
RRP: Various



Part no.	Description	RRP
V92623	Direct inlet air filter, 1/4" male NPT reinforced	\$7.48
V92624	Direct inlet air filter, 3/8" male NPT reinforced	\$4.50
V92625	Remote inlet air filter, 3/8" x 1/2" tube fitting	\$9.50
V92630	Metal air filter, 1/4" NPT	\$12.65

QUICK CONNECT COUPLER / STUD

Part No: Various
RRP: Various



Part no.	Description	RRP
V92813	Quick connect coupler, 1/4" male	\$9.00
V92814	Quick connect coupler, 1/4" female	\$9.00
V92815	Quick connect stud, 1/4" male	\$2.75
V92818	Quick connect stud, 1/4" female	\$2.75

MULTIPOINT FITTINGS

Part No: Various
RRP: Various



Part no.	Description	RRP
V92821	Female tee/billet manifold, 1/4" f x 1/4" f x 1/8" f	\$8.25
V92846	T-fitting, 1/4" m x 1/4" f x 1/8" f NPT	\$12.00
V92848	T-fitting, 1/4" m x 1/4" f x 1/4" f	\$17.00
V92855	4-way fitting, 1/4" m x 1/4" f x 1/4" f x 1/8" f, NPT	\$28.71

REDUCERS

Part No: Various
RRP: Various



Part no.	Description	RRP
V92810	Reducer NPT fitting, 1/4" male to 1/4" male	\$2.75
V92811	Reducer, 1/4" male to 1/8" male	\$8.09
V92812	Reducer, 1/4" male to 1/8" female	\$2.75
V92840	Reducer, 3/8" male to 1/4" male NPT	\$5.50
V92841	Reducer, 3/8" male to 1/4" female NPT	\$7.70
V92842	Reducer, 3/8" female to 1/4" male NPT	\$7.70
V92843	Reducer, 3/8" female to 1/4" female NPT	\$7.70

CHECK VALVES

Part No: Various
RRP: Various



Part no.	Description	RRP
V92823	Check valve NPT, 1/8" male to 1/8" female, OD.12mm, nickel	\$6.50
V92824	Check valve NPT, 1/8" male to 1/8" female, OD.16mm, nickel	\$6.50
V92825	Check valve NPT, 1/8" female to 1/8" male, OD.16mm, nickel	\$6.50
V92831	Check valve, 1/4" female to 1/4" male, nickel plated	\$8.25
V92832	Check valve, 1/4" male to 1/4" female	\$8.25
V92833	Check valve, 3/8" female to 3/8" male	\$10.45

DRAIN COCK, 1/4" NPT

Part No: V92835
RRP: \$5.28

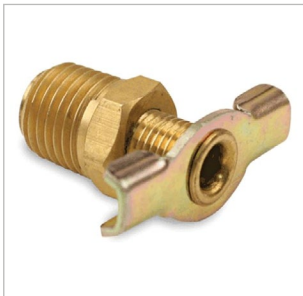

6-PORT BILLET MANIFOLD & BRACKET

Part No: V92820
RRP: \$27.50w



Kit includes

- (6) 1/4" NPT Ports
- Mounting Bracket
- Mounting Hardware (1/4" Air Line)
- 1 x T-Fitting (Dual 1/4" NPT – Air Out)

COMPRESSOR FITTING, 1/4" LINE, 1/8" FEMALE

Part No: V92838
RRP: \$6.38



INFLATION VALVE, 1/4" AIRLINE

Part No: V92839
RRP: \$12.32



RRP subject to change. Listed recommended retail prices are for the Australian Domestic Market.



CAMPING

FOLDING SHOVEL WITH BAG

Part No: 73X05/A
RRP: \$29.70



The Bushranger® Tri-Fold Shovel is a simple, compact tool, but an essential on the open road.

Specifications

- Material: blade 2mm heat treated steel with moulded nylon handle
- Dimensions: closed 25cm (L) x 15cm (W) x 5cm (D)
- Dimensions: open 60cm (L) x 15cm (W) x 5cm (D)
- Weight: 1.2kg
- Warranty: 5 years

DIGGAR SHOVEL

Part No: 73X40
RRP: \$88.00



Features

- Strong and durable designed, 2mm thick heat treated blade with 36mm multi-core fiberglass handle with rubber grips.
- Compact 3 piece design, breaks down into 3 pieces (max 760mm) that stores away neatly when not in use in a handy carry bag.
- Multi-Use Long handle shovel and D-Handle spade.

Specifications

- Material: blade 2mm heat treated steel, 36mm multi-core fibreglass handle and rubber grip
- Dimensions: closed 76cm (L) x 19cm
- Dimensions: open 147.5cm (L) x 19cm (W)
- Long handle Shovel: 147.5cm
- D Handle Spade: 96cm
- Blade width: 19cm
- Weight: 3.3kg
- Warranty: 1 years

WHEELIE BIN | 67L

Part No: 61X08B
RRP: \$99.00

Features

- Rigid self-supporting 57L main compartment, which is complete with a moveable, ridged centre divider, two (2) side pockets, each with 5L capacity. (Total capacity 67L) and three vented eyelet in the base to allow liquids to drain.
- It's hard-wearing reinforced PVC especially manufactured and reinforced 1000D material, double thickness padded base and partial walls for extra strength and durability.
- The large overlapping flap has been increased in size to better protect against dust entry and a reflective strip for increased visibility, night-time safety, and warning.
- Four (4) 25mm side release buckles securely hold the main lid in place, improving ease of use, and securing.
- UV tested in Australia by a certified laboratory to AS2001.2.3.1-01 and will stand up to colour fade.
- Easy to install, remove and hose down after use
- Warranty: 5 years

Specifications

- Dimensions: 45.5x19.5x64.5cm
- Weight: 2.3kg
- Warranty: 5 years



RACK SACK WITH CARGO NET

Part No: Various
RRP: Various

Features

- Made from 600 denier nylon fabric and all seams triple sewn.
- 100% weatherproof with large overlapping flap, Velcro tabs which is designed to cover large continuous double slider zipper that assists to protect against water entry.
- Easy to adjust stretch cargo net with adjustable hooks.
- Warranty: 5 years

Part no.	Dimensions	Weight	RRP
64X22	1220mm x 1520mm x 330mm, large	3.4kg	\$210.10
36Z00	Seam sealer, 50ml		\$8.25



BUSH PACK

Part No: Various
RRP: Various

Features

- Easy to adjust tie down straps
- Large continuous double slider zipper, zips around sides and rear with Velcro tabs at each bottom corner and non-slip self locking buckles.
- Includes carry bag, and repair kit.
- Warranty: 5 years

Part no.	Dimensions	Weight	RRP
64X11	1180mm x 980mm x 330mm, medium	2.8kg	\$341.00
64X12	1520mm x 1220mm x 330mm, large	3.4kg	\$399.30



HOT WATER SHOWER | VEHICLE MOUNTED

Part No: 78X01
RRP: \$517.00

The Bushranger® Vehicle Mounted Hot Water Shower is an essential product for any adventure, use as a shower, to wash dishes or filling your reservoir. Mounted inside your engine bay, there are no bulky parts to carry and no complex set-ups to go through. Simply plug two quick connect hoses, drop one in some water and hook the shower head up above your head and you're ready for the hot flowing water.

Features

- Fully serviceable quiet marine grade pump.
- Easy-to-fit plumbing, and wiring kit.
- 100% copper heat exchanger with a bleed point.
- Comes complete with universal mounting brackets.
- Easy to install, remove and hose down after use
- Warranty: 5 years

Specifications

- Volume: 12L per Minute
- Dimensions (pump): 160mm x 160mm x 200mm
- Dimensions (heat exchanger): 120mm x 80mm x 340mm
- Weight: 5.4kg
- Warranty: 1 year
- Note: Heater hose is not included in this kit.

HOT WATER SHOWER ACCESSORIES & SPARE PARTS

Part no.	Description	RRP
78X09	Anodic protection kit, suits 78X01	\$27.50
78X65	Wash down kit	\$99.00
78X50	Shower spray set with 1.5m hose	\$17.60
78X63	Heater hose, 15.9mm x 20m	\$110.00
78X51	12VDC diaphragm pump, electrical	\$217.50
78X53	Coil bends, stainless steel	\$7.00
78X68	Bug caps, 13mm, 4 pack	\$11.50
78X69	Hot water shower connector kit	\$59.50
78X52/A	Heat exchanger	POA



RECOVERY

TYRE MAINTENANCE

LIGHTS

COMPRESSORS

CAMPING

VEHICLE PROTECTION

SIDE STEPS

WINDOWS

PORTABLE GAS HOT WATER SHOWER KIT

Part No: 78X04
RRP: \$295.00

Features

- Water flow and temperature sensors
- Maximum water temperature shut off, unit will shut off if temperature exceeds 50 degrees
- Tilt switch, if unit is bumped or knocked over, an automatic shut down will occur
- Flame failure safety device
- Automatic electronic gas ignition

Specifications

- Dimensions: 500mm x 300mm x 140mm
- Weight: 4.7kg
- AS2658, AS4621, AS/NZS1869 Standards
- Australian & New Zealand Gas Safety Certification (meets new 2018 standards)
- Warranty: 1 Year

Complete Kit Includes:

- Modern designed shower unit
- Multi spray pattern shower rose with hose and on/off control
- 12V 4.3L per minute pump
- 2 x D batteries
- 2 x 1.5 metre hoses with fittings
- 2.5m Fused power cable with on/off switch.
- Optional alligator clamps and cigarette plug included
- Gas hose & regulator
- Owners Manual



Note: Not included; LPG Gas, 12V Power and watersource.

GAS HOT WATER SHOWER ACCESSORIES & PARTS

Part no.	Description	RRP
78X90	High Flow Pump Kit	\$155.00
78X91	GHWS Carry Bag	\$40.00
78X87	GHWS Battery Box Spare Part	POA
78X84	GHWS Shower Hose Chrome	\$72.00
78X83	GHWS Shower Rose	\$72.00
78X81	GHWS Gas Hoses + Regulator	\$72.00
78X82	GHWS 12.5l/m Pump	\$231.88
78X97	GHWS Rubber foot pumps (each)	\$1.00
78X92	GHWS 4.3l/m pump	\$40.00
78X93	Pressure switch 4.3l/m pump	\$10.00
78X94	GHWS power cables kit	\$15.00
78X95	GHWS Water Hoses (1x1.5m crimped, 1/2BSP fitting, 1x1.5m hose)	\$10.00
78X96	GHWS 12.5l/m Pump pressure switches	\$20.00
78X80	Front face, suits 78X02	POA
78X81	Gas hose, regulator, suits 78X02	\$72.00
78X82	Pump, 12.5L, suits 78X02	\$231.88
78X83	Shower rose, suits 78X02	\$72.00
78X84	Shower hose, 1.5m, suits 78X02	\$72.00
78X85	Knobs (gas, water, burner, high and low), chrome, set of 3	POA



BUSHRANGER AWNING

Part No: Various
RRP: Various



Features

- Main beam aluminium extrusion: Twin Channel, for extra strength and rigidity.
- Outer cover: Heavy duty 1200D/680g PVC Fabric. UV stabilised.
- Awning cover: Rip-stop 600D Polyester canvas PU coating, UPF 50+, UV stabilised, mold resistant, waterproof (3000mm hydrostatic head rating)
- 2 x velcro straps hold awning securely in outer bag, and secured by a double zipped outer bag for quick and easy pack up.
- Stitched and welded seams
- Flexible joints: Polyethylene (PE) composite helps to prevent damage to rafter poles and legs, allowing for a larger setup angle unlike brittle plastic or aluminium joints. 180 degree flexibility.
- All aluminium parts are anodised for resistance to oxidization and wear.
- Twist locks on telescopic poles for simple, durable operation

Specifications

AW2000	2055mm (L) x 90mm (W) x 110mm (H) (closed) 2500mm (L) x 2000mm (W) x 2100mm (H), Adjustable (open)
AW2500	2555mm (L) x 90mm (W) x 110mm (H) (closed) 2500mm (L) x 2500mm (W) x 2100mm (H), Adjustable (open)

BUSHRANGER AWNING

Part no.	Description	Weight	RRP
AW2000	Bushranger Awning 2.0m x 2.5m	10kg	\$289.00
AW2500	Bushranger Awning 2.5m x 2.5m	10kg	\$299.00

AWNING ENCLOSURE

Part No: OS3015
RRP: \$259.00

Features

- 5 different mix and match styles of set-up you can create a solution for almost every need.
- Built using our comprehensive 5 panel mosquito protection system (4 walls and a ceiling) and covered with a PU-coated polyester canvas.
- Quick and easy to set up, supplied with guy ropes, pegs, poles and storage bag.

Specifications

- Dimensions: 2500mm (L) x 2500mm (W) x Adjustable (H)
- Colour: Green
- Weight: 8kg
- Warranty: 1 years



BREATHABLE GROUND SHEET

Part No: OS3400
RRP: \$99.00



Specifications

- Colour: black
- Dimensions: 2400mm (L) x 2500mm (W)
- Material: Strong Polyester Yarn individually coated with PVC
- Material (Carry Bag): 600D Polyester with "PU" coating
- Weight: 3.2kg
- Warranty: 1 years

QUICK STEP

Part No: 51X00/A
RRP: \$79.95



Features

- Anti-slip perforated tread plate for high grip in any condition.
- Safely and effectively access your vehicle roof without the need for awkward ladders or standing in awkward positions to manoeuvre.
- Also makes a great seat, and ideal for tradies or delivery drivers.
- Easy to install and use
- Holds up 150kg of weight

Specifications

- Dimensions: 595mm x 360mm x 85mm (flat)
- Weight: 4.9kg
- Warranty: 5 Years

RRP subject to change. Listed recommended retail prices are for the Australian Domestic Market.

Kingsley

ROOF RACK



VEHICLE PROTECTION

CARGO BAR

Part No: 73X04
RRP: \$55



The Bushranger® Cargo Bar installs in seconds to easily secure your load in ute beds, trailers 4x4 etc. A quick action ratchet mechanism is simple to tighten, lock and release. 180cm long when fully extended, 105cm long when fully retracted. Stores compactly away when not in use.

Specifications

- Dimensions: 105cm, 180cm (fully extended)
- Pad size: 8cm x 6cm (rubber)
- Material: Steel construction
- Weight: 2.2kg
- Warranty: 1 year

ANCHOR TRACK | 2M

Part No: 67X04
RRP: \$93.50



Features

The Bushranger Anchor Track is a multi-purpose fully adjustable tie down anchoring system for utes, vans, 4WD's, trailers, trucks or wherever tie down points are required. Anchor eyelets are sold separately and have a breaking strain rated to 150kg each.

2 metres, 25 rivets.

Specifications

- Length: 2m
- Breaking strain: 150kg each
- Warranty: 1 year

Part no.	Description	RRP
67X04	Anchor Track, 2m, 25 rivets	\$93.50
67X01	Anchor Track Eyelets	\$9.90

UTE TIE DOWN | TWIN PACK

Part No: 73X11
RRP: From \$28.60



The Bushranger® Ute Tie Downs are classic in design, as originally fitted on Ford F100. Suitable for use on all smooth sided utes, including dual cabs, falcons etc. Secure any load with this versatile system. Easy to install using supplied pop rivets. Made from moulded plastic gasket, chrome plated die cast metal, will not rust.

Specifications

- Material: Chrome plated die cast metal
- Dimensions: 140mm x 40mm with a 35mm profile
- Weight: 450g
- Warranty: 5 years

SPARE WHEEL COVERS

Part No: Various
RRP: Various

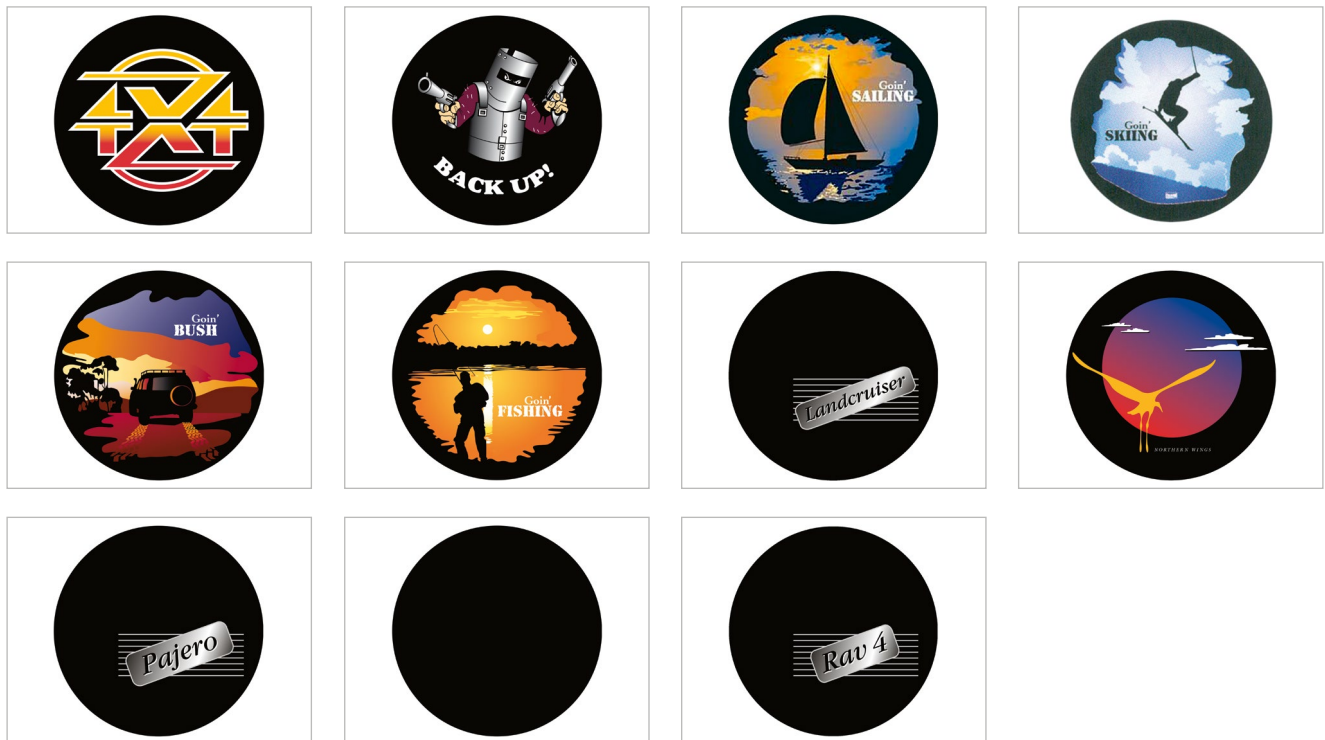

The Bushranger® Spare Wheel Covers protects your spare tyres from dust, mud and corrosion, whilst adding looks and personality. Easy to install with an elastic cord to ensure a snug fit. Made from high quality UV stable vinyl with fleece backing. Available in 4 sizes and a variety of designs.

BUSHRANGER CARAVAN SPARE WHEEL COVERS

(FITS TYRE DIAMETERS 600MM - 660MM, COMMON SIZE: 14", 15" TYRES)

Part no.	Description	RRP
81Z82C	Northern Wings	\$55.00
81Z92C	Goin' Fishing	\$55.00
81Z88C	Plain Black	\$55.00
81Z85C	Back up Ned Kelly	\$55.00
81Z98C	Goin' Bush	\$55.00

BUSHRANGER SMALL SPARE WHEEL COVERS

(FITS TYRE DIAMETERS 650MM - 710MM, COMMON SIZE: 205.75R15 | 215.75R15 | 215.70R16 | 195.80R15)

Part no.	Description	RRP
81Z88S	Plain Black	\$55.00
81Z87S	4X4	\$55.00
81Z95S	Goin' Sailing	\$55.00
81Z96S	Goin' Skiing	\$55.00
81Z82S	Northern Wings	\$55.00
81Z98S	Goin' Bush	\$55.00
81Z92S	Goin' Fishing	\$55.00
82T28S	RAV4	\$71.50

BUSHRANGER LARGE SPARE WHEEL COVERS

(FITS TYRE DIAMETERS 720MM - 780MM, COMMON SIZE: 10R15 | 275.70R16 | 265.70R15 | 235.60R16 | 225.70R15)

Part no.	Description	RRP
81Z88L	Plain Black	\$55.00
81Z87L	4X4	\$55.00
81Z85L	Back Up-Ned Kelly	\$55.00
81Z82L	Northern Wings	\$55.00
81Z96L	Goin' Skiing	\$55.00
81Z95L	Goin' Sailing	\$55.00
81Z98L	Goin' Bush	\$55.00
81Z92L	Goin' Fishing	\$55.00
82M50L	Pajero	\$71.50
82S75L	Landcruiser	\$71.50

BUSHRANGER EXTRA LARGE SPARE WHEEL COVERS

(FITS TYRE DIAMETERS 790MM - 850MM, COMMON SIZE: 750R16 | 265.75R16 | 235.85R16 | 255.85R16)

Part no.	Description	RRP
83Z88X	Plain Black	\$64.90
83Z87X	4X4	\$64.90
83Z95X	Goin' Sailing	\$64.90
83Z96X	Goin' Skiing	\$64.90
83Z82X	Northern Wings	\$64.90
83Z92X	Goin' Fishing	\$64.90
83S75X	Landcruiser	\$71.50
83Z98X	Goin' Bush	\$64.90

PRO-FORM SPORTGUARD

Part No: Various
RRP: \$597.97



The Pro-form® Sportguard™ is a revolutionary bed protection system. PRO-FORM set out to develop a protection system for your ute bed that overcomes limitations with existing protection options.

Sportguard™ is the first bed protection system that offers the following:

Sportguard™ is truly non-skid – cargo won't slide around in the ute bed;

Sportguard's sleek, contoured design both enhances the overall visual appearance of your truck, maximises your pickup's load space and enables seamless use of any standard tie hook or accessory option.

Pro-form's Sportguard™ offers a unique combination of formed to fit style; tough, durable material and an intuitive 'snap-fit' installation which makes it a true revolutionary protection system.

Part no.	Description	RRP
26F97D	Sportguard - Ford Ranger, 2011 - Onwards	\$594.97
26F97D	Sportguard - Mazda BT-50 D-Cab, 2011 - 2020	\$594.97
26H96D	Sportguard - Holden Colorado, 2012 - Onwards	\$594.97
26H96D	Sportguard - Isuzu D-Max D-Cab, 2012 - 2020	\$594.97
26Z10D	Sportguard - Mazda BT-50 D-Cab, Isuzu D-Max D-cab 07/2020 - Onwards	\$594.97
26M66D	Sportguard - Mitsubishi Triton L200 D-Cab, 2014 - Onwards	\$594.97
26T93D	Sportguard - Toyota Hilux D-Cab, 2015 - Onwards	\$594.97
26T93D-J	Sportguard - Toyota Hilux J-Deck D-Cab, 2015 - Onwards	\$594.97
26V20D	Sportguard - VW Amarok D-Cab, 2010 - Onwards	\$594.97

RECOVERY
TYRE MAINTENANCE
LIGHTS
COMPRESSORS
CAMPING
VEHICLE PROTECTION
SIDE STEPS
WINDOWS

FLEXY FLARES

Part No: Various
RRP: Various

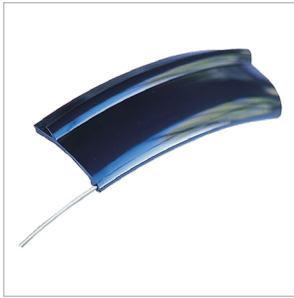

The Bushranger® Flexy Flare aids in protecting your vehicle and other vehicles from mud and stone damage. Tough rubber construction: Spring Steel in outer edge, easy to install.

Specifications

- 1 x 3m length to fit minimum 2 wheel arches
- Warranty: 5 Years

Part no.	Description	RRP
13X66	35mm	\$90.20
13X68	65mm	\$93.50

MOULDED MUD FLAPS

Part No: Various
RRP: Various



The Bushranger® Moulded Mud Flaps protects your vehicle, caravan or trailer against stones, mud and other debris. Easy to install and clean. UV stable protection.

Specifications

- Warranty: 5 Years

Part no.	Description	RRP
56X01	Small, 260mm x 360mm	\$50.00
56X00	Large, 300mm x 460mm	\$55.00

DIRT BLOCKA FLOOR MATS

Part No: Various
RRP: Various

The Bushranger® Dirt Blocka Mat is designed with deep edges to capture all the debris that is brought into the vehicle, from sand, dirt, mud, snow, even water can be contained within the mats. Made from a solid rubber construction that retains integrity and shape and easy to clean. A 5cm high perimeter ridge to keep debris enclosed from your interior material. Underside of mat features ribs to prevent mat slippage. Generous size to suit even the largest 4x4, they can also be trimmed to suit your foot well. Available in black.

Specifications

- Front: 730mm (L) x 490mm (W) x 50mm (D)
- Rear: 380mm (L) x 490mm (W) x 50mm (D)
- Warranty: 5 Years

Part no.	Description	RRP
68X05	Front mat	\$27.50
68X10	Rear mat	\$15.00



MUD TAMER FLOOR MATS

Part No: Various
RRP: Various

The Bushranger® Mud Tamer Floor Mats are designed with deep edges to capture all the debris that is brought into the vehicle, from sand, dirt, mud, snow, even water can be contained within the mats. Made from a solid rubber construction that retains integrity and shape and easy to clean. A high perimeter ridge to keep debris enclosed from your interior material. The underside of mat features pips to prevent mat slippage. Generous size, they can also be trimmed to suit your foot well.

Specifications

- Front: 730mm (L) x 490mm (W) x 50mm (D)
- Rear: 380mm (L) x 490mm (W) x 50mm (D)
- Warranty: 3 Years

Part no.	Description	RRP
91X01B	Black - Front	\$55.00
91X02B	Black - Rear	\$35.20
91X01C	Charcoal - Front	\$55.00
91X02C	Charcoal - Rear	\$35.20



UNIVERSAL BOOT SAVER

Part No: 78X00
RRP: \$64.90



The Bushranger® Universal Boot Saver Liner is made from heavy-duty anti-slip rubber that won't tear, crack or warp. Easy to clean, simply remove from the vehicle and hose. 8cm side lip to contain any spillages. Fits most vehicles.

Specifications

- Dimensions: 63cm x 90cm
- Warranty: 1 year

UNIVERSAL CARGO MATS

Part No: Various
RRP: Various



The Kingsley® Universal fit Cargo Mats Heavy duty rubber won't tear, crack or warp. Flat surface means easy loading and unloading. Available in 5 universal sizes: 5'x8', 5'x10', 6'x8', 6'x10' and multi-fit suiting Japanese double cab utes.

Part no.	Description	RRP
44X01	Multifit cargo mat, all Japanese double cab utes	\$155.10
47X26	Universal cargo mat 1524mm x 2438mm (5'x8')	\$204.60
47X27	Universal cargo mat 1575mm x 3030mm (5'x10')	\$248.60
47X28	Universal cargo mat 1830mm x 2440mm (6'x8')	\$225.50
47X29	Universal cargo mat 1830mm x 3048mm (6'x10')	\$279.40

CARGO MATS

Part No: Various
RRP: Various



The Kingsley® Rubber Cargo Mats are designed to protect the floor of the cargo space in your vehicle and aid slippage of cargo. Made from solid construction rubber, these mats will not crack, tear or warp. They are resistant to most household chemicals fuels and liquids. Dimple backing on the underside to hold in place.

Standard & moulded types available.

TIMBER FLOORS

Part No: Various
RRP: Various



The Kingsley® Timber Floors for commercial vans, an essential workhorse for vehicle longevity and usability. They provide a tough surface for cargo, work equipment, conversions to passenger vehicles and RV's. They are easy to move loads across, you can mount tie-down points through it and it can really take a beating all the while keeping your van floor safely protected and as good as new.

Features

Durable | manufactured from 12mm CD Grade 5-Ply and engineered to specifically match each van. Kingsley Timber Floors follow the contours of your van cargo area, giving your vehicle that finished look.

Precision joins | the timber floors are CNC-routed and each section is joined together using a tongue and groove joint for maximum strength, the tongue and groove joint runs the entire length of the two joining sections creating a completely aligned and smooth surface.

TAILGATE MATS

Part No: Various
RRP: Various



The Kingsley® Rubber Tailgate Mats are designed to protect your tailgate from unwanted dings and scratches, which are the main causes of rust. Heavy duty rubber, won't tear, crack or warp.

WAGON LINERS

Part No: Various
RRP: Various



The Pro-form® Wagon Liners are a robust poly-resin protection mat for the rear cargo area of your AWD, 4WD or wagon. They are custom moulded to specifically suit most 4WD's and people movers. The wagon liners contain a rubberised top surface to reduce sliding of items, and a raised outer edge to contain spills and mud.

FOR VEHICLE AVAILABILITY VIEW PRICE LIST OR VISIT

[BUSHRANGER.COM.AU/VEHICLE-SEARCH-RESULTS](https://bushranger.com.au/vehicle-search-results)

ROGUE SIDE STEPS

Part No: 50 Series
RRP: From \$798.60



- Anodised aluminium finish with black components.
- Non-slip step pads
- Zinc plated brackets
- Warranty: 3 years

Features

- Heavy duty steel construction step, with steel mounting brackets. The step is coated with high grade polyester powder coat in a textured matt black finish.
- A full width step offers a robust barrier from stones, mud or whatever else the wheels throw up, protecting your vehicle from damage.
- Designed and engineered locally, for each vehicle, ensuring a snug fit, maintaining an increased ground clearance compared to most factory fitted steps, and SRS side curtain airbag compliant.
- Carefully designed, contoured to match the sill panel and remove the risk of injury by closing this gap.

INTEGRA SIDE STEPS

Part No: 30 Series
RRP: From \$630



- Anodised aluminium finish with black components.
- Non-slip step pads
- Zinc plated brackets
- Warranty: 5 years

Features

- Tested to perform, a full width step offers a robust barrier from stones, mud or whatever else the wheels throw up, protecting your vehicle from damage.
- Engineered locally, for each vehicle, ensuring a snug fit, maintaining ground clearance, and SRS side curtain airbag compliant. Carefully designed rear kickboard is contoured to match the sill panel and remove the risk of injury by closing this gap.
- Airbag compliant

STEPBOARD SIDE STEPS

Part No: 18 Series
RRP: From \$570



- Anodised aluminium finish with black components.
- Non-slip step pads
- Zinc plated brackets
- Warranty: 5 years

Features

- Designed and engineered locally, for each vehicle, ensuring a snug fit, maintain ground clearance, and SRS side curtain airbag complaint.
- Carefully designed rear kickboard is contoured to match the sill panel and remove the risk of injury by closing this gap.
- Tested to perform a full width step offers a robust barrier from stones, mud or whatever else the wheels throw up, protecting your vehicle from damage.

BLACK INTEGRA STEPS

Part No: 35 Series
RRP: From \$745



- Strong and durable AkzoNobel UV Stable powder coat finish, the steps will not dull or fade
- Non-slip step pads
- Zinc plated brackets
- Warranty: 5 years

Features

- Designed and engineered locally, for each vehicle, ensuring a snug fit, maintain ground clearance, and SRS side curtain airbag complaint.
- Carefully designed rear kickboard is contoured to match the sill panel and remove the risk of injury by closing this gap.
- A full width step offers a robust barrier from stones, mud or whatever else the wheels throw up, protecting your vehicle from damage.

RRP subject to change. Listed recommended retail prices are for the Australian Domestic Market.



WINDOWS

JET-TEC SLIDING WINDOW

Part No: Various
RRP: Various



Jet-Tec Sliders are designed using cutting-edge technology provides a sleek, simple look. Jet-Tec windows are manufactured from a single piece of glass with an integral hole, to allow for the sliding window. This cutting-edge method increases the strength of the window, visibility, drainage, and ventilation. Jet-Tec's have noise dampening incorporated into each and every moving part and feature a high-quality, US made glazing seal. Kingsley Enterprises offer a comprehensive range of Jet-Tec windows to suit your needs. Flyscreens are also available to suit.

Warranty: Limited lifetime

BONDED SLIDING WINDOW

Part No: Various
RRP: Various



Kingsley® Bonded Sliding Window, a Urethane mounted van window. They offer great ventilation for your cargo area on any commercial vehicle and are ideal for van conversions into transport vehicles and campervans. These sleek stylish windows enhance the appearance of the vehicle while offering practicality and usability to your van.

Warranty: Limited Lifetime

CLAMP RING SLIDING WINDOW

Part No: Various
RRP: Various



Kingsley® Clamp Ring Sliding Windows have been the leading sliding window choice for vans over the years, they offer fantastic ventilation for the back of your van and make an excellent window for any camper conversion or passenger van conversion.

Warranty: Limited lifetime

BONDED FIXED WINDOW

Part No: Various
RRP: Various



Kingsley® Fixed Windows are engineered sleek and simple design, this is the staple throughout the industry and perfect off the shelf solution. Kingsley windows are commonly used in camper van conversions and passenger vehicle conversions Australia wide. The urethane mounted, making for an easy installation, removing the need for perishable mounting items such as rubber or breakable parts such as fixed clamp ring windows. Made with a tinted, toughened safety glass, with exact radius corners and smooth lines enhance the van's appearance. The curved glass matches the van body for perfect fit.

Warranty: Limited Lifetime

RUBBER MOUNTED SLIDING WINDOW

Part No: Various
RRP: Various



Kingsley® Rubber Mounted Sliding Window, designed to suit older model vehicle's where we can incorporate the original 'string-in' installation or to swap out the existing rubber mounted fixed window for a ventilated glass.

Warranty: Limited lifetime

RUBBER MOUNTED FIXED WINDOW

Part No: Various
RRP: Various



Kingsley® Fixed Windows are engineered sleek and simple design, this is the staple throughout the industry and perfect off the shelf solution. Kingsley windows are commonly used in camper van conversions and passenger vehicle conversions Australia wide. Designed to suit older model vehicle's where we can incorporate the original 'string-in' installation or to offer added visibility around the vehicle.

Warranty: Limited lifetime

GENERAL PURPOSE WINDOWS

Part No: Various
RRP: Various



Kingsley® Fixed Windows are engineered sleek and simple design, this is the staple throughout the industry and perfect off the shelf solution. General purpose off the shelf window solutions are suitable for use in truck bodies, sleepers, horse floats, trailers, and vans etc. Left hand and right-hand windows available. The windows are made from black frames, flat clear glass, clamp-ring sliders.

Warranty: Limited Lifetime

WINDOW ACCESSORIES

Part No: Various
RRP: Various

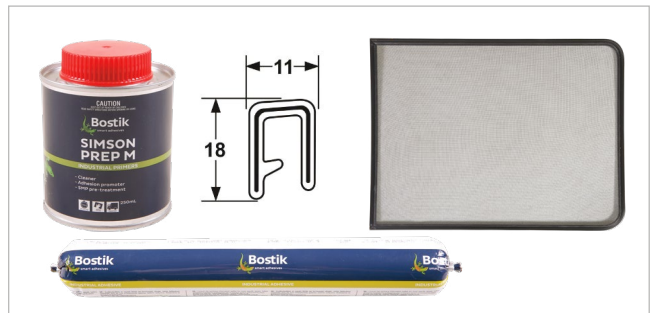

Part no.	Description	List
92Z033	Flyscreen beading, 0.125", per metre	\$5.00
92Z082	Flyscreen beading, 0.140", per metre	\$5.00
92Z007	D' Section rubber, 50m roll	\$10.00
92Z007	D' Section rubber, per metre	\$10.00
33Z06	Sponge tape, 8mm x 3mm	\$13.18
33Z08	Sponge tape, 8mm x 6mm	\$10.45
33Z12	Aero strip, 1.3m	\$22.27
33Z05	Pinch weld, 17mmx12mm, shiny finish, 50m	\$284.09
33Z11	Pinch weld, 17mmx12mm, matt finish, 50m	\$364.55
33Z09	Pinch weld, 9mmx7mm, shiny finish, 100m	\$3.60
33Z20	Pinch weld, suits Hiace Commuter	\$24.55
92Z019	Internal trim, 20m	\$96.36
94Z405	Bostik simson ISR70-08 adhesive, 600ml	\$48.64
94Z406	Bostik simson primer M, 250ml	\$55.00
94Z415	Adhesive promoter, primer, 25ml	\$6.82

FOR VEHICLE AVAILABILITY VIEW PRICE LIST OR VISIT
BUSHRANGER.COM.AU/VEHICLE-SEARCH-RESULTS

Kingsley Enterprises, the company behind the Bushranger 4x4 Gear brand, started from humble beginnings back in 1977. The Australian love for the big wide country, the love of exploring in a 4x4 was starting to explode. People of all walks of life were keen to get off-road, explore and test their vehicles limits.

Over the last four decades, Bushranger has grown with the 4x4 community and today we are a leader, offering a comprehensive range of accessory products that are engineered and designed by our in-house engineering team. We've tried and tested each and every product that wears the Bushranger brand name. When purchasing a Bushranger product, you can be sure it meets Australian standards, it is safe, practical, robust and will perform day in, day out in the harsh Australian landscape. At Bushranger, we know you want equipment that you can rely on to get you there and back.

Explore with us, be a bushranger, "most wanted" for 40 years.



ABOUT US

BUSHRANGER

4x4 GEAR

bushranger.com.au



Free Call | 1800 654 767 (Australia only)

International | +61 2 8700 0400

Fax | +61 2 8700 0499

Email | sales@kingsleyenterprises.com.au

Address | 6A Brooks Road, Ingleburn NSW 2565